

DATA SHEET



Model : Marigold-I

Ver. 1.2



Apr 07, 2016

#705, 149, Gondan-ro,
Gunpo-Si, Gyunggi-Do, Korea, 15845
Tel : 82-31-427-8101
Fax : 82-31-427-8108
Web site: www.estecom.co.kr

CONTENTS

1.	Revisions of History	-----	3
2.	General Descriptions	-----	4
3.	Features	-----	4
4.	Block Diagram	-----	5
5.	Outline Dimensions	-----	6
6.	Connectors Information	-----	8
7.	Reference Data	-----	14
8.	Supported Input Formats	-----	15
9.	OSD	-----	16
10.	RS-232 communication	-----	24

The information presented in this document may form a part of quotation or contract under the agreement of both parties. Otherwise, this datasheet is subject to change without prior notice.

1. Revisions of History

Revision No.	Date	Page	Description
Ver. 1.0	Jan.16	All	First Draft, Preliminary Specification
Ver. 1.1	Jan. 28	16~24	Added OSD information.
Ver. 1.2	Apr. 07	4, 20~24	Updated temp range and OSD menus

2. General Descriptions

Marigold-I is an advanced TFT-LCD Monitor Control Board. This design enables a full conventional CRT monitor and/or video replacement with a large size Active Matrix LCD module. It is suitable for video resolution up to WUXGA @ 60Hz(1080 vertical by 1920 horizontal pixel array) in all video modes, the full display area of the module is used. The design is implemented as a single printed circuit board.

Marigold-I is designed to support various TFT-LCDs up to WUXGA resolution by Firmware option.

3. Features

- Designed to give state-of-the-art picture quality
- Analog RGB / HDMI, and Displayport.
- Analog Audio In, and SPDIF through HDMI, Displayport.
- Various input combination, e.g., PC monitor only
- Full CRT multi-sync monitor compatibility
- Multi-sync capability up to WUXGA resolution @ 60Hz, compatible standard SVGA, XGA and SXGA VESA timing.
- Expand DOS,VGA,SVGA,XGA, SXGA,UXGA and full HD to full screen display
- True color (16.7M) data processing and display driving
- Single control operated & transparent On-Screen-Display (hereafter 'OSD') user interface
- Full control of all relevant display and interface parameters via OSD
- PIP function available.
- VESA DDC 1/2B compliant
- Compatible with VESA DPMS power saving modes
- Form factor: 100mm (L) x 150mm (W) x 19mm(H)
- +12V or +24V DC single power
- Operating temperature: -20°C to 70°C

4. Block Diagram

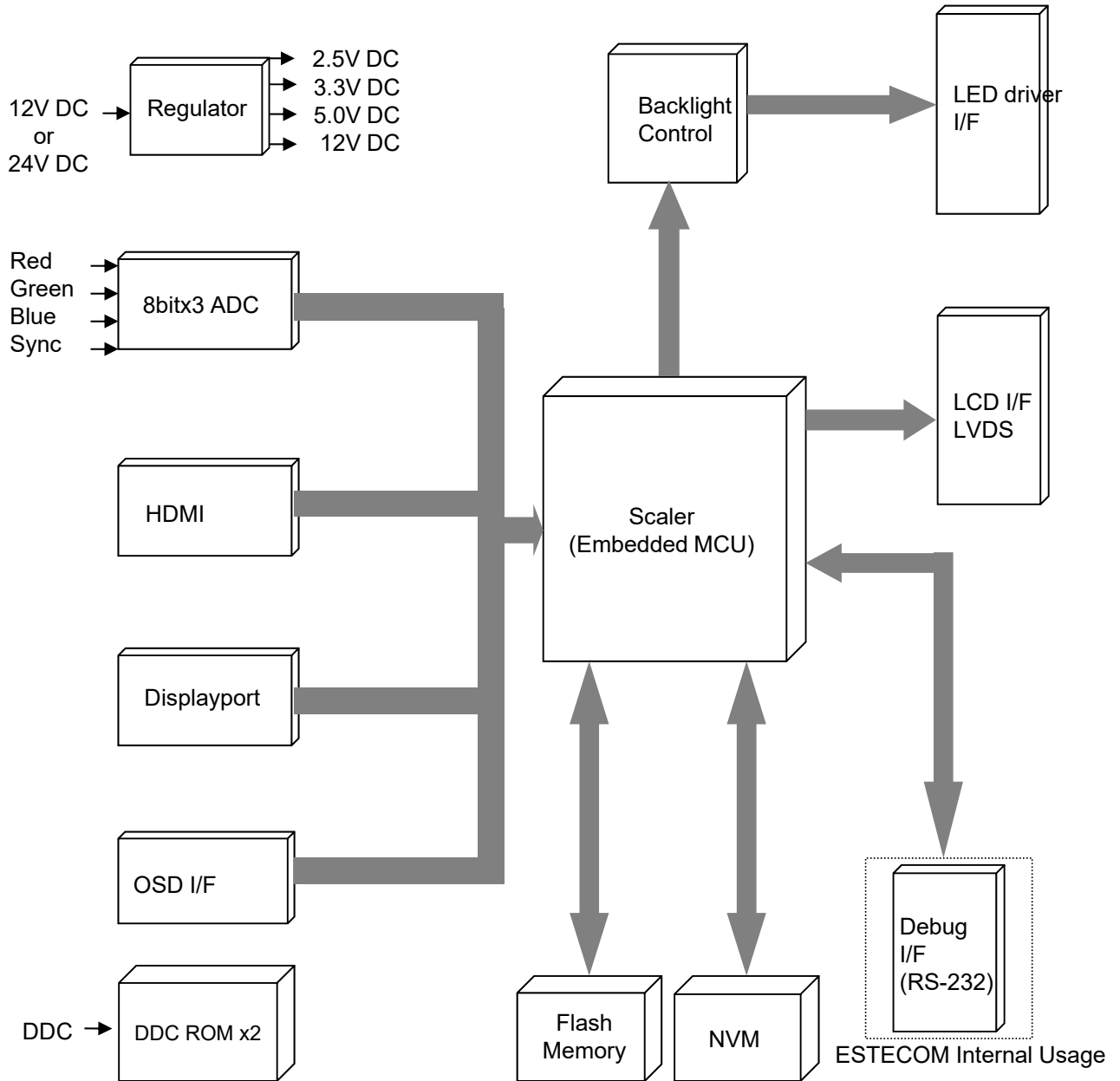

5. Outline Dimensions

5.1 Standard Connectors with Special Power connector 4P angle (3.96mm pitch)

- Dimension : 100mm (L) x 150mm (W) x 19mm(H)

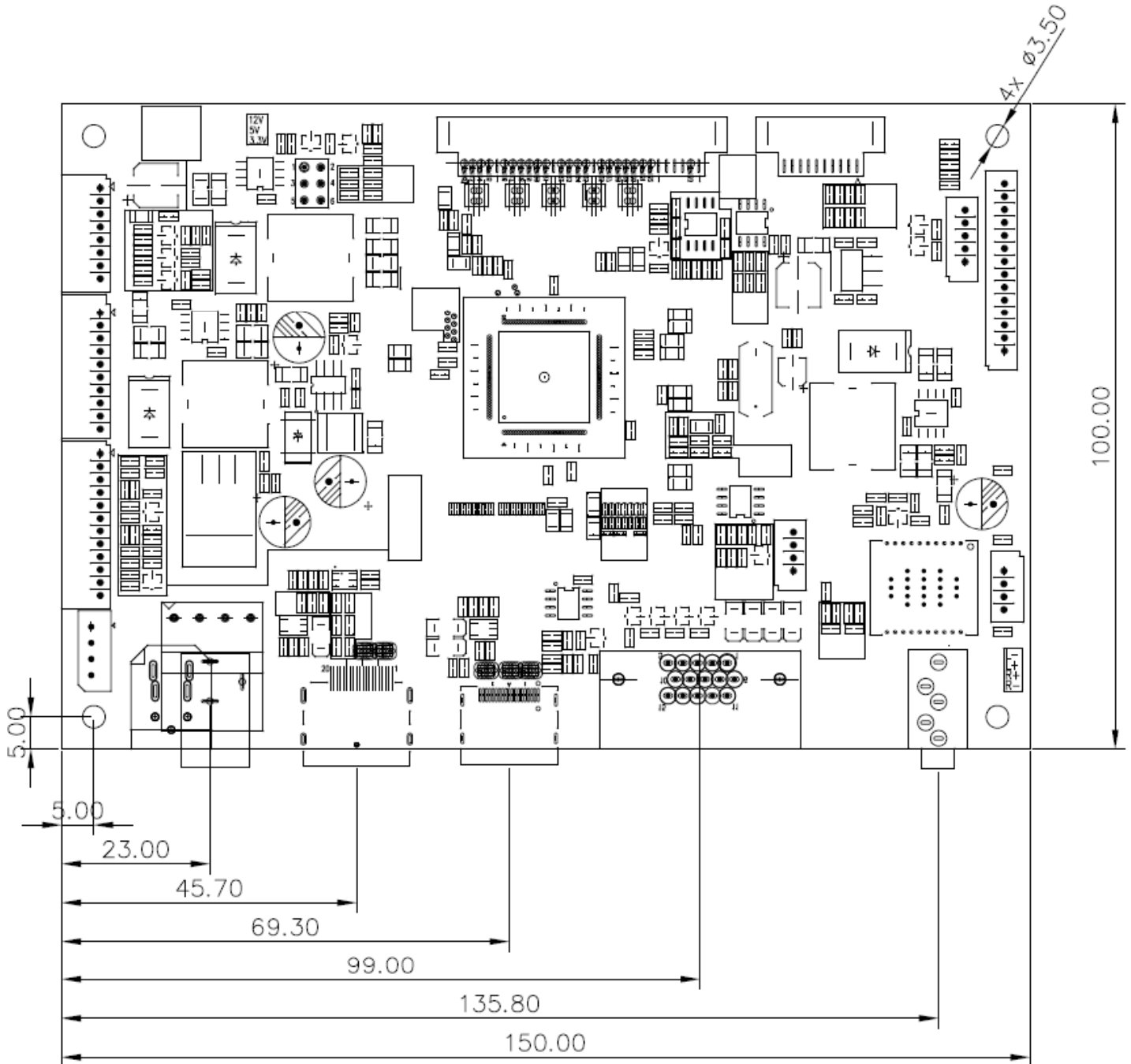

5.2 Actual connectors location

- Analog, DVI, Displayport and interface connector

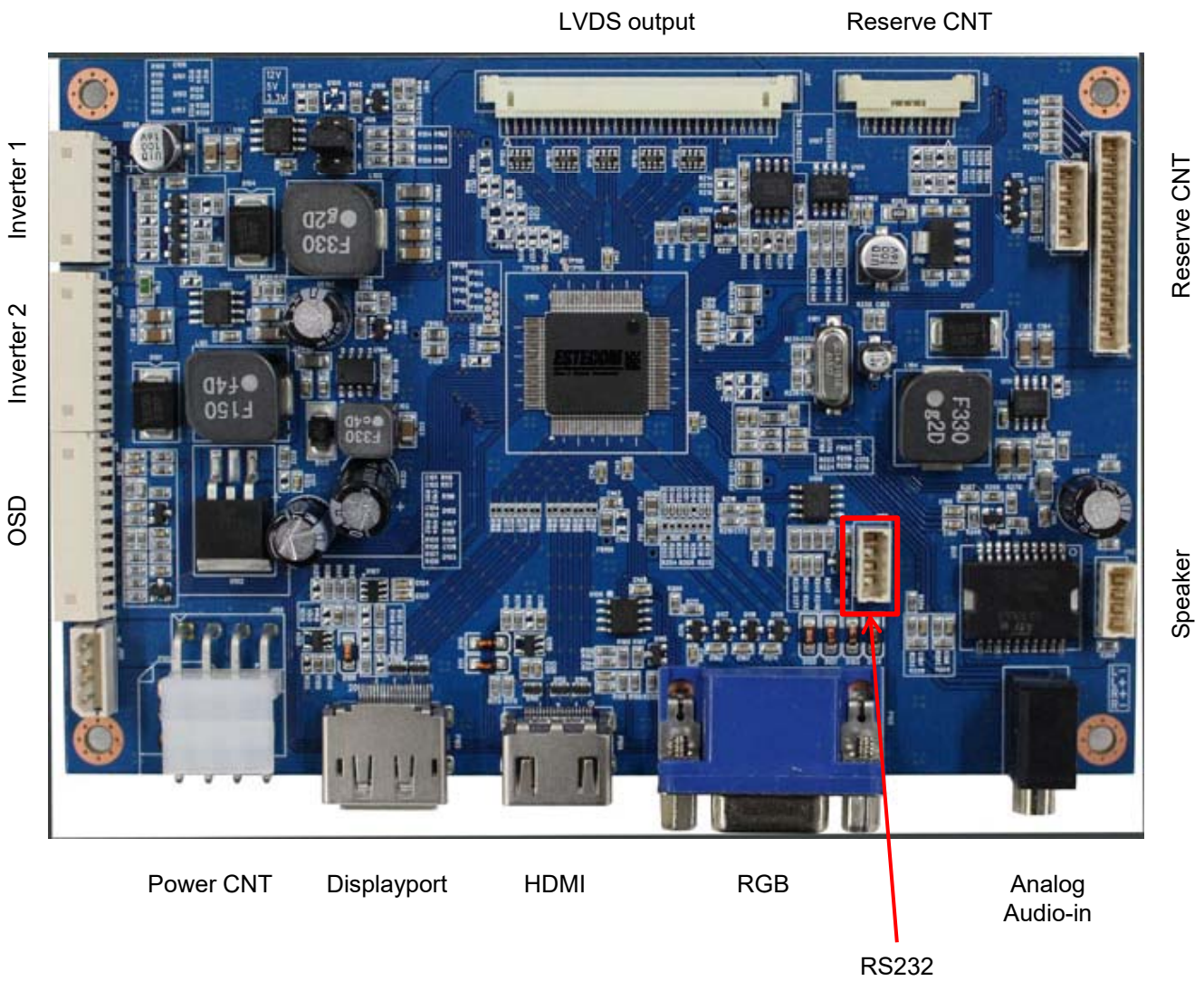

6. Connectors Information

6.1 Input Connectors

- Power Input Connector
Connector : DC12V Jack (P102)



Pin No.	Symbol	Description	Pin No.	Symbol	Description
1, 2	GND	GND	3	Vin	+12V DC

- Power Input Connector
Connector : Molex 5267-04 (J101)

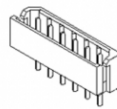

Pin No.	Symbol	Description	Pin No.	Symbol	Description
1	VCC	POWER	3	GND	GND
2	VCC	POWER	4	GND	GND

- Power Input Connector **(Alternative)**
Connector : Hanlim LA1143_4(J105)

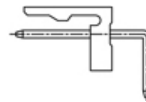

Pin No.	Symbol	Description	Pin No.	Symbol	Description
1	VCC	POWER	3	GND	GND
2	VCC	POWER	4	GND	GND

- Power Input Connector **(Alternative)**
Connector : Power DIN Jack (P101)



Pin No.	Symbol	Description	Pin No.	Symbol	Description
1	GND	RETURN	3	GND	RETURN
2	VCC	POWER(DC24V)	4	GND	POWER(DC24V)

- Analog RGB Input Connector
Connector : Mini D_Sub 15pin(P105)



Pin No.	Symbol	Description	Pin No.	Symbol	Description
1	RED	Analog Red	9	NC	+5V DC
2	GREEN	Analog Green	10	SGND	Sync GND
3	BLUE	Analog Blue	11	NC	No Connection
4	GND	No Connection	12	SDA	DDC Serial Data
5	GND	Digital GND	13	HSYNC	Horizontal Sync
6	RGND	Red Return	14	VSYNC	Vertical Sync.
7	GGND	Green Return	15	SCL	DDC Data Clock
8	BGND	Blue Return			

- HDMI Input Connector
Connector : xxx HDMI-19P-SMD (P104)



Pin No.	Symbol	Pin No.	Symbol	Pin No.	Symbol
1	HDMI Data2+	8	GND	15	DDC Serial Clock
2	GND	9	HDMI Data0-	16	DDC Serial Data
3	HDMI Data2-	10	HDMI Clock+	17	GND
4	HDMI Data1+	11	GND	18	Bus Power(+5V)
5	GND	12	HDMI Clock-	19	Hot Plug Detect
6	HDMI Data1-	13	C.E.C	20	
7	HDMI Data0+	14	N/C		

● Displayport Input Connector

Connector : xxx SGDF-0199 (P103)



Pin No.	Symbol	Pin No.	Symbol	Pin No.	Symbol
1	LANE 3-	8	GND	15	AUX CH+
2	GND	9	LANE 1+	16	GND
3	LANE 3+	10	LANE 0-	17	AUX CH-
4	LANE 2-	11	GND	18	HPD
5	GND	12	LANE 0+	19	Return
6	LANE 2+	13	GND	20	DP Power
7	LANE 1-	14	C.E.C		

● OSD, LED Interface Connector :

Connector : 53015-1210 made by Molex (J104)

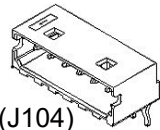

Pin No.	Symbol	Description	Pin No.	Symbol	Description
1	LED 1	LED 1	7	KEY2	Increase
2	LED 0	LED 0	8	KEY3	Decrease
3	Vcc	Vcc 5V	9	KEY4	Down
4	IR	Remote control	10	KEY5	Menu
5	GND	GND	11	KEY6	Source Select
6	KEY1	Power	12	KEY7	Up

● RS-232C Connector :

Connector : 53014-0410 made by Molex (J108)

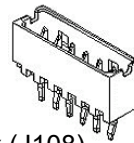

Pin No.	Symbol	Description	Pin No.	Symbol	Description
1	GND	GROUND	3	Rx	RxD
2	Tx	TxD	4	VCC	+5VDC

6.2 Output Connectors

- LVDS Output Connector (J107)

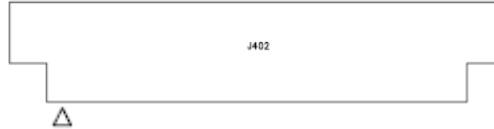

Pin No.	Symbol	Descripton	Pin No.	Symbol	Descripton
1	Tx0-E	Even data	16	Tx1+O	Odd data
2	Tx0+E	Even data	17	GND	Return
3	Tx1-E	Even data	18	Tx2-O	Odd data
4	Tx1+E	Even data	19	Tx2+O	Odd data
5	GND	Return	20	TxCLK-O	Odd data
6	Tx2-E	Even data	21	TxCLK+O	Odd data
7	Tx2+E	Even data	22	Tx3-O	Odd data
8	TxCLK-E	Even data	23	Tx3+O	Odd data
9	TxCLK+E	Even data	24	GND	Return
10	Tx3-E	Even data	25	3.3V	LVDS option
11	Tx3+E	Even data	26	GND	Return
12	GND	Return	27	VCC	Module Power
13	Tx0-O	Odd data	28	VCC	Module Power
14	Tx0+O	Odd data	29	VCC	Module Power
15	Tx1-O	Odd data	30	VCC	Module Power

- PC Sound Input Connector (P106)

Input Connector : xxx ST-351



Pin No.	Symbol	Description	Pin No.	Symbol	Description
1	GND	GROUND	3	L+	PC sound Left -
2	R+	PC sound Right +	4	GND	GROUND
3	GND	GROUND			

- Backlight Connector
Connector : 53015-0810 made by Molex (J102)

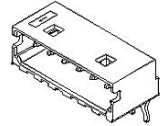

Pin No.	Symbol	Description	Pin No.	Symbol	Description
1	BRIGHT	Brightness Adjustment	5	GND	Ground
2	ON/OFF	Backlight On/Off	6	GND	Ground
3	GND	Ground	7	12V	12V
4	5V	5V (Not Use)	8	12V	12V

- Backlight Power Connector (For Large size panel)
Connector : 53015-1010 made by Molex(J103)

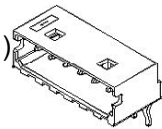

Pin No.	Symbol	Description	Pin No.	Symbol	Description
1	VDD	INV PWR	6	GND	Ground
2	VDD	INV PWR	7	GND	Ground
3	VDD	INV PWR	8	GND	Ground
4	VDD	INV PWR	9	GND	Ground
5	VDD	INV PWR	10	GND	Ground

- Speaker Output Connector
Connector : 53014-0410 made by Molex (J112)

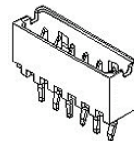

Pin No.	Symbol	Description	Pin No.	Symbol	Description
1	L-	Speaker Left -	3	R+	Speaker Right +
2	L+	Speaker Left +	4	R-	Speaker Right -

- Reserve Connector
Connector : 53014-1410 made by Molex (J111)

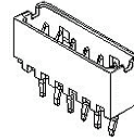

Pin No.	Symbol	Description	Pin No.	Symbol	Description
1	GPIO1	General Purpose I/O	8	INT	Interrupt
2	GPIO2	General Purpose I/O	9	VCC	+5VDC
3	GPIO3	General Purpose I/O	10	PNL_PWR	LCD panel power
4	GND	GROUND	11	GND	GROUND
5	ADC	ADC	12	GND	GROUND
6	SDA	I2C	13	VDD	+12VDC ~24VDC
7	SCL	I2C	14	VDD	+12VDC~24VDC

- Light Sensor Connector
Connector : 53014-0510 made by Molex (J110)

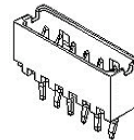

Pin No.	Symbol	Description	Pin No.	Symbol	Description
1	VCC	+5VDC	3	GND	GROUND
2	SDA	I2C	4	VPP	+3.3VDC
3	SCL	I2C			

7. Reference Data

Video Input Timing;

Supported vertical refresh rates for each modes are as follows:

640 x 350	70Hz
640 x 400	70Hz
700 x 560	55~75Hz
720 x 350	70Hz
720 x 400	70Hz
640 x 480	60~75Hz
800 x 600	60~75Hz
1024 x 768	60~75Hz
1152 x 864	60~75Hz
1280 x 1024	60~75Hz
1280 x 768	60~75Hz
1366 x 768	60~75Hz
1440 x 900	60~75Hz
1600 x 1200	60~75Hz
1680 x 1050	60~75Hz
1920 x 1080	60Hz
1920 x 1200	60Hz

Sync. : H/V Separated TTL, Composite Sync

● Electrical Parameters

Reference Cosmos, t_A 25 ° C

Symbol	Description	Min	Type	Max	Unit
V_{DD}	+12V (+24V) DC Power Supply	10.8	12.0	24.5	V
$V_{i(RGB)}$	Video Input Signal (w.r.t. GND)	0.5	0.7	1.0	V_{PP}
f_S	Video Sample Rate			80	MHz
f_{HS}	Horizontal Sync. Frequency	30		60	KHz
f_{vs}	Vertical Sync Frequency	56		75	Hz
F_{SIH}	Sync Input High Level	2.5			V
V_{SIL}	Sync Input Low Level			0.8	VDC
I_{DD2}	Supply Current +12V (with LCD & Inverter)		2.5	3	A

Note 1. Power consumption measuring condition is 2 pixel check board pattern @ SXGA 75Hz and maximum brightness with Samsung LTM170E6 & inverter at t_A 25°C.

8. Supported Input Formats

8.1 Video Mode Support

The Marigold-I series can support any video mode within the following input constraints:

- Signal sample frequency with the input $\leq 80\text{MHz}$
- Horizontal sync frequency between 30KHz and 80KHz

The modes are detected with the presentation of the input and previous alignments for setup are Automatically recalled. The emulation of a true multi-sync monitor is implemented.

The factory preset supported modes are as follows:

Mode	Resolution	Refresh rate	H-freq.	Pixel freq.	Remarks
VGA	640 x 350	70Hz	31.47KHz	25.175MHz	VESA Standard
VGA	720 x 400	59.940HZ	31.469KHZ	25.175MHZ	IBM VGA 3H
VGA	640 x 480	60Hz	31.5KHz	25.175MHz	Industry Standard
VGA	640 x 480	72Hz	37.9KHz	31.500MHz	VESA Standard
VGA	640 x 480	75HZ	37.5KHZ	31.500MHZ	VESA Standard
SVGA	800 x 600	60Hz	37.9KHz	40.000MHz	VESA Guidelines
SVGA	800 x 600	72Hz	48.1KHz	50.000MHz	VESA Standard
SVGA	800 x 600	75HZ	46.9KHZ	49.500MHZ	VESA Standard
XGA	1024 x 768	60Hz	48.4KHz	65.000MHz	VESA Guidelines
XGA	1024 x 768	70Hz	56.5KHz	75.000MHz	VESA Standard
XGA	1024 x 768	75HZ	60KHZ	78.750MHZ	VESA Standard
SXGA	1280 x 1024	60Hz	64KHZ	108.000 MHZ	VESA Standard
SXGA	1280 x 1024	75HZ	80KHZ	135.000 MHZ	VESA Standard
WXGA	1280 x 768	60~75Hz	47.7~65KHZ	80.140 MHZ	Not Standard
WXGA	1366 x 768	60~75Hz	47.7~65KHZ	80.000 MHZ	Not Standard
WSXGA	1440 x 900	60~75Hz	65KHZ	150.000 MHZ	Not Standard
WSXGA	1680 x1050	60Hz	70KHZ	150.000 MHZ	Not Standard
WUXGA	1920 x1080	60Hz	95KHZ	190.000 MHZ	Not Standard

Notes:

1. All mentioned modes are non-interlaced. The maximum and minimum frame rates are determined by the TFT-LCD.
2. Factory preset modes are overwritten by additional user alignments for automatic recall. The factory preset modes can be recalled at any time.

9. OSD (On Screen Display)

9.1 OSD Board Dimension

9.1.1 OSD Board with 6 Buttons

Part number : SGLM0000700

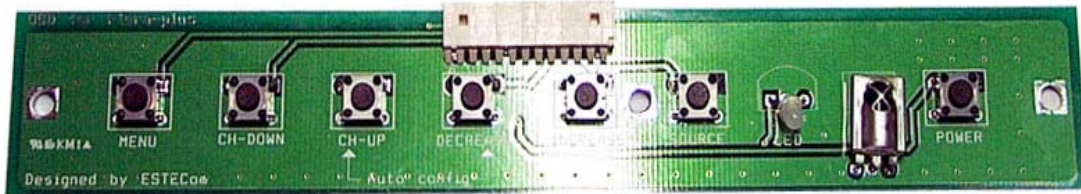

MENU / DOWN / UP / DECREASE(LEFT) / INCREASE(RIGHT) / SOURCE / POWER

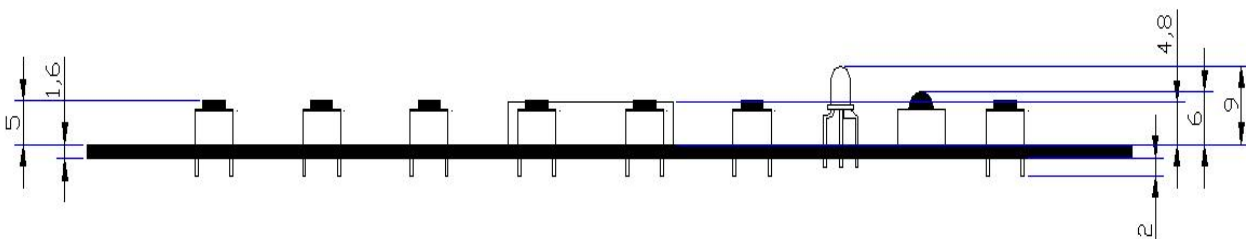
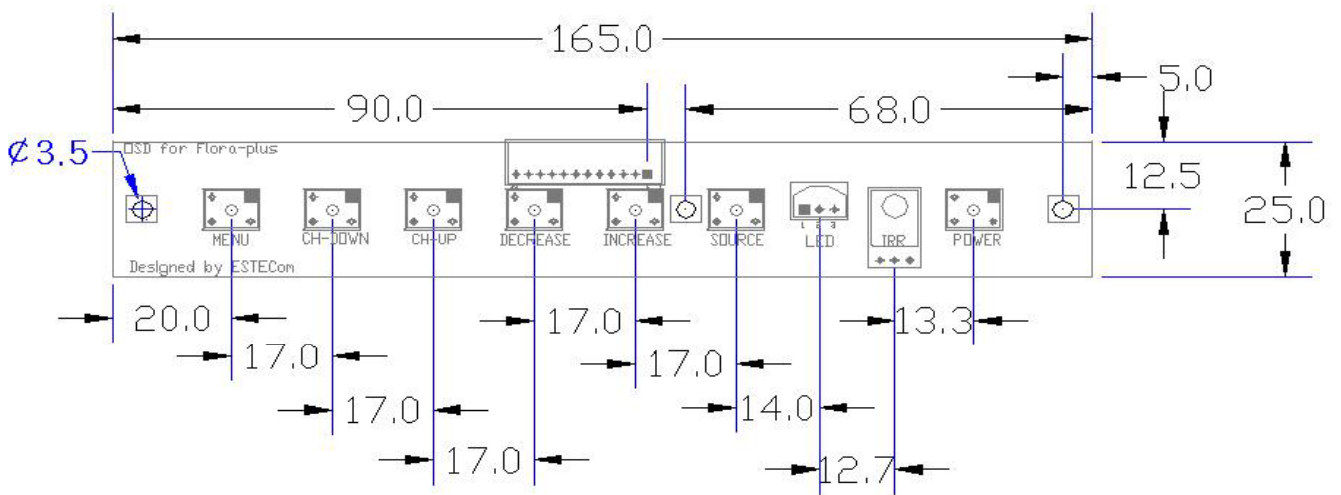

OSD Key Description

- **MENU** : Menu Key
- **DOWN** : Down Key
- **UP** : Up Key
- **DECREASE** : Enter to Sub menu ,Decrease Key or Left Key
- **INCREASE** : Enter to Sub menu, Increase Key or Right Key
- **SOURCE** : Source Select OSD On key

Hot Key Description

- **MENU** : Menu Popup / Menu exit
- **DOWN** : Auto adjustment, VGA only
- **UP** : Brightness menu popup.
- **DECREASE** : Contrast menu popup.
- **INCREASE** : Volume menu popup.

9.2 Summary of OSD Menu

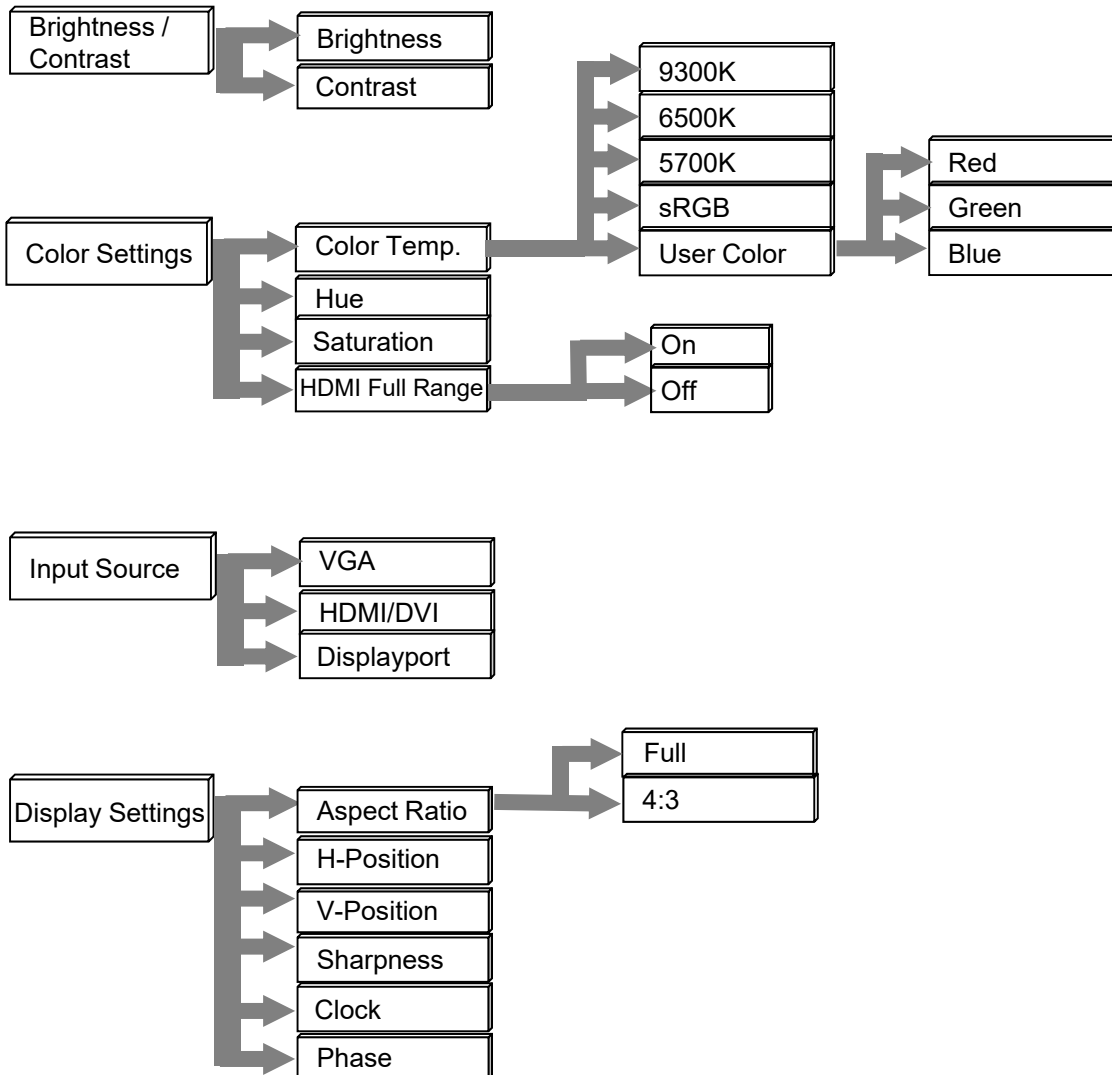

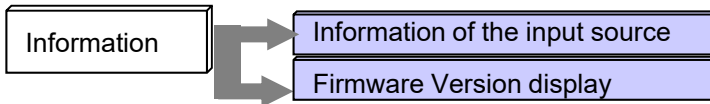
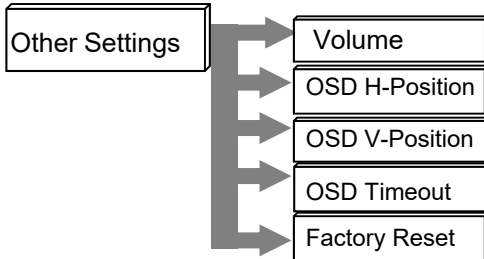

[Note]





 : Adjustment does not available.





 **Auto Adjust** **This function activated when VGA input**

9.3 OSD menu enables user to manipulate the image & settings



Brightness/Contrast	Auto Select	
Color Settings	• VGA	
Input Source	HDMI/DVI	
Display Settings	Displayport	
Other Settings		
Information		
Auto Adjust		

Brightness/Contrast	Aspect Ratio	Full
Color Settings	H.Position	 50
Input Source	V.Position	 50
Display Settings	Sharpness	 50
Other Settings	Clock	 50
Information	Phase	 21
Auto Adjust		

Brightness/Contrast	Volume		50
Color Settings	OSD H.Position		50
Input Source	OSD V.Position		50
Display Settings	OSD Timeout		10
Other Settings	Factory Reset		
Information			
Auto Adjust			

Brightness/Contrast	Resolution: 1920 x 1080	
Color Settings	H.Freq: 68KHz	
Input Source	V.Freq: 60Hz	
Display Settings	V.Total: 1125 Lines	
Other Settings	Color Format: RGB	
Information		
Auto Adjust		
	FWR 0XXX – Y.YYZZ	

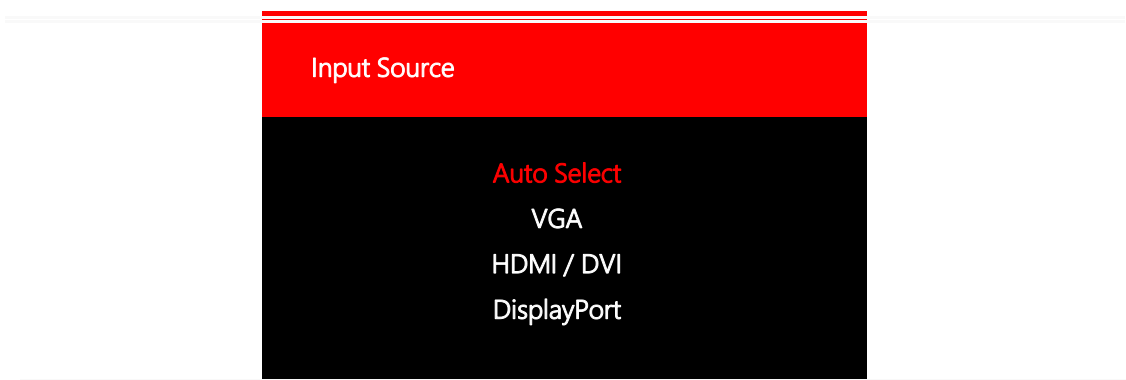

User has an option selectable Auto source function and Manual source function. This pop up message will come on when user press "Source" button on OSD board.

10 . RS-232 communication protocol.

10.1 Purpose

To control monitor remotely by RS-232 protocol.

10. 2 Command Length

- LENGTH : 5 bytes

10. 3 Check Sum

- SUM of each byte : FF

10. 4 Definition of byte

AA BB CC DD EE

AA : Start string of COSMOS II RS-232 commands.

BB : String of command function.

CC : String of Set or Get value

DD : Blank string, normally "00"

EE : added string to meet checksum "FF". $(AA+BB+CC+DD + EE) = FF$

10. 5 Baud rate

- Must be set 9600 rate

6. RS-232 communication protocol.

Function	Command	Description
Menu	BF 06 00 00 3A	Menu Popup
Down	BF 09 00 00 37	Auto adjust Hot key
UP	BF 04 00 00 3C	Brightness Hot key
Decrease	BF 05 00 00 3B	Contrast Hot key
Increase	BF 07 00 00 39	Volume Hot key
Source	BF 08 00 00 38	Source select key
Power	BF 00 00 00 40	Power key
Source change VGA	BF 0A 00 00 36	Direct command
Source change HDMI/DVI	BF 0B 00 00 35	Direct command
Source change Displayport	BF 0C 00 00 34	Direct command
Get Brightness	BF 01 00 00 3F	
Increasing Brightness	BF 2D 00 00 13	
Decreasing Brightness	BF 03 00 00 3D	
Get Contrast	BF 0F 00 00 31	
Increasing Contrast	BF 2E 00 00 12	
Decreasing Contrast	BF 11 00 00 2F	
Power Off	BF 31 00 00 0F	
Power On	BF 32 00 00 0E	
Backlight Off	BF 33 00 00 0D	
Backlight On	BF 34 00 00 0C	
Get Backlight status	BF 35 00 00 0B	
Place Factory reset	BF 30 00 00 10	
Get Input Source status	BF 1E 00 00 22	
Get Power status	BF 1F 00 00 21	

Function	Command	Description
Get PC Red Color Value	BF 13 00 00 2D	
Get PC Green Color Value	BF 14 00 00 2C	
Get PC Blue Color Value	BF 15 00 00 2B	
Set PC Color Temp (increase)	BF 16 00 00 2A	0 - 1 - 2 - 3 - 4
Set PC Color Temp (decrease)	BF 17 00 00 29	4 - 3 - 2 - 1 - 0
<i>0: Cool, 1: Normal, 2: Warm, 3: sRGB, 4: User</i>		
Increase PC RED color value	BF 18 00 00 28	
Decrease PC RED color value	BF 19 00 00 27	
Increase PC Green color value	BF 1A 00 00 26	
Decrease PC Green color value	BF 1B 00 00 25	
Increase PC Blue color value	BF 1C 00 00 24	
Decrease PC Blue color value	BF 1D 00 00 23	
Set Brightness value	BF 02 1E 00 20	<i>Brightness 30</i>
	BF 02 38 00 06	<i>Brightness 56</i>
	BF 02 5D 00 E1	<i>Brightness 93</i>
Set Contrast value	BF 10 00 00 30	<i>Contrast 30</i>
	BF 10 23 00 0D	<i>Contrast 35</i>
	BF 10 5A 00 D6	<i>Contrast 90</i>