



DATA SHEET



Model : POPPY-O II

Ver. 0.2

July 6, 2012

#705, Gunpo Hyundai I Valley, Dang-Dong,
Gunpo-Si, Kyunggi-Do, Korea, 435-010

Tel : 82-31-427-8101

Fax : 82-31-427-8108

Web side: www.estecom.co.kr



CONTENTS

1.	Revisions of History	-----	3
2.	General Descriptions	-----	4
3.	Features	-----	4
4.	Block Diagram	-----	5
5.	Outline Dimensions	-----	6
6.	Connectors Information	-----	8
7.	Reference Data	-----	13
8.	Supported Input Formats	-----	14
9.	On Screen Display	-----	16
10.	RS-232 communication protocol	-----	21

The information presented in this document may form a part of quotation or contract under the agreement of both parties. Otherwise, this datasheet is subject to change without prior notice.



1. Revisions of History

Revision No.	Date	Page	Description
Ver. 0.1	May '1	All	First Draft, Preliminary Specification
Ver. 0.2	July '6	#21~#26	Add RS-232 protocol



2. General Descriptions

Poppy-O II is an advanced TFT-LCD Monitor Control Board. This design enables a full conventional CRT monitor and/or video replacement with a large size Active Matrix LCD module. It is suitable for video resolution up to WUXGA @ 60Hz in all video modes, the full display area of the module is used. The design is implemented as a single printed circuit board.

3. Features

- Designed to give state-of-the-art picture quality
- Analog RGB / DVI or HDMI.
- Optional input combination, e.g., PC monitor only
- Full CRT multi-sync monitor compatibility
- Multi-sync capability up to WUXGA resolution @ 60Hz, compatible standard SVGA, XGA and SXGA VESA timing.
- Expand DOS,VGA,SVGA,XGA, SXGA and WUXGA to full screen display
- Single control operated & transparent On-Screen-Display (hereafter 'OSD') user interface
- Full control of all relevant display and interface parameters via OSD
- VESA DDC 1/2B compliant
- Compatible with VESA DPMS power saving modes
- Form factor
Poppy-O II Board -> 96mm (L) x 96mm (W) x 15mm(H)
- +12VDC Single power input.
- Operating temperature: 0°C to 50°C
- The IR ,UART & RS232 function (full remote control)integrated.

4. Block Diagram

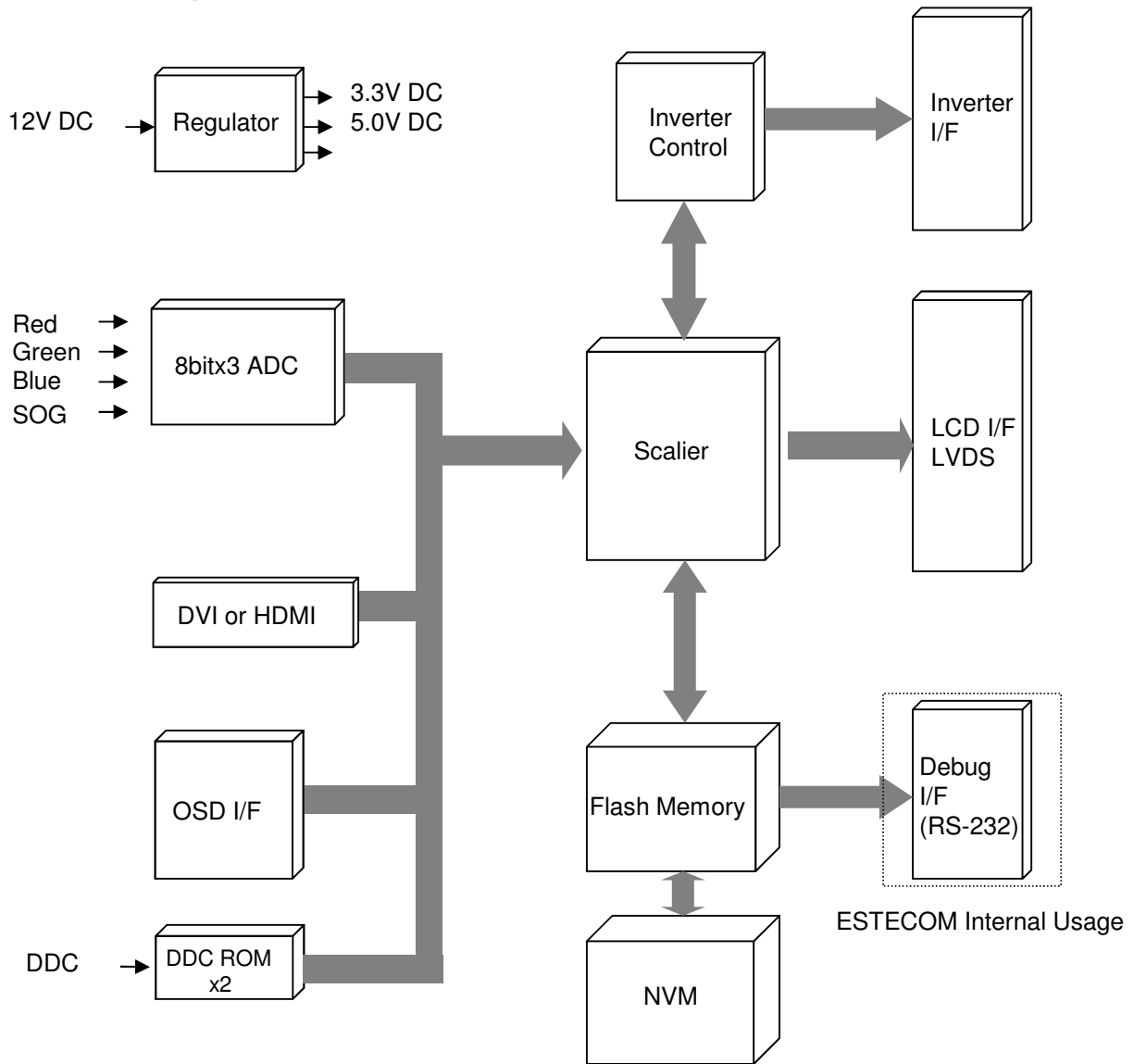

5. Outline Dimensions

5.1 Low profile Connectors

- Dimension : 96mm (L) x 96mm (W) x 15mm(H)

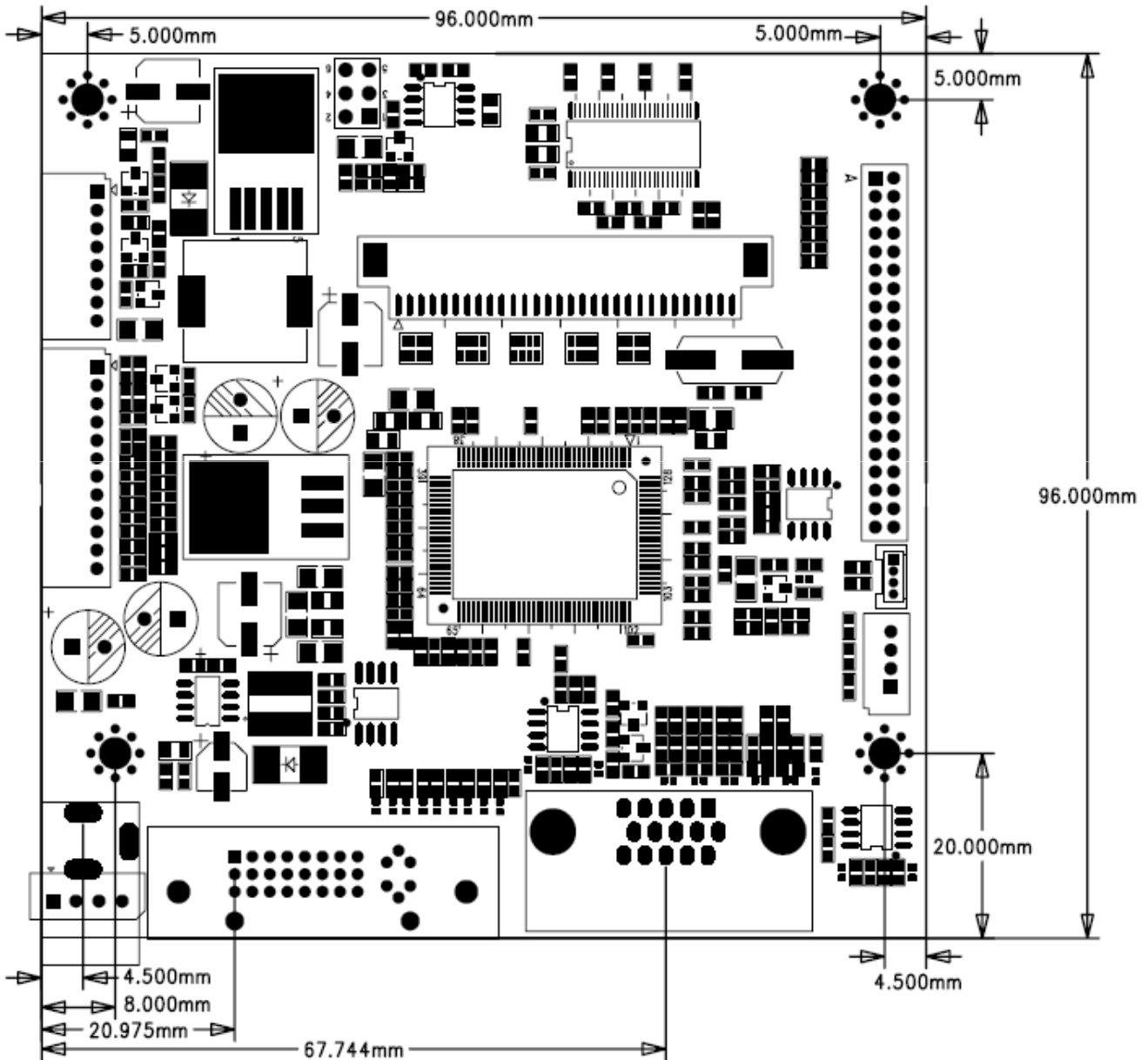

5.1.1 Actual connectors location

- Analog, DVI

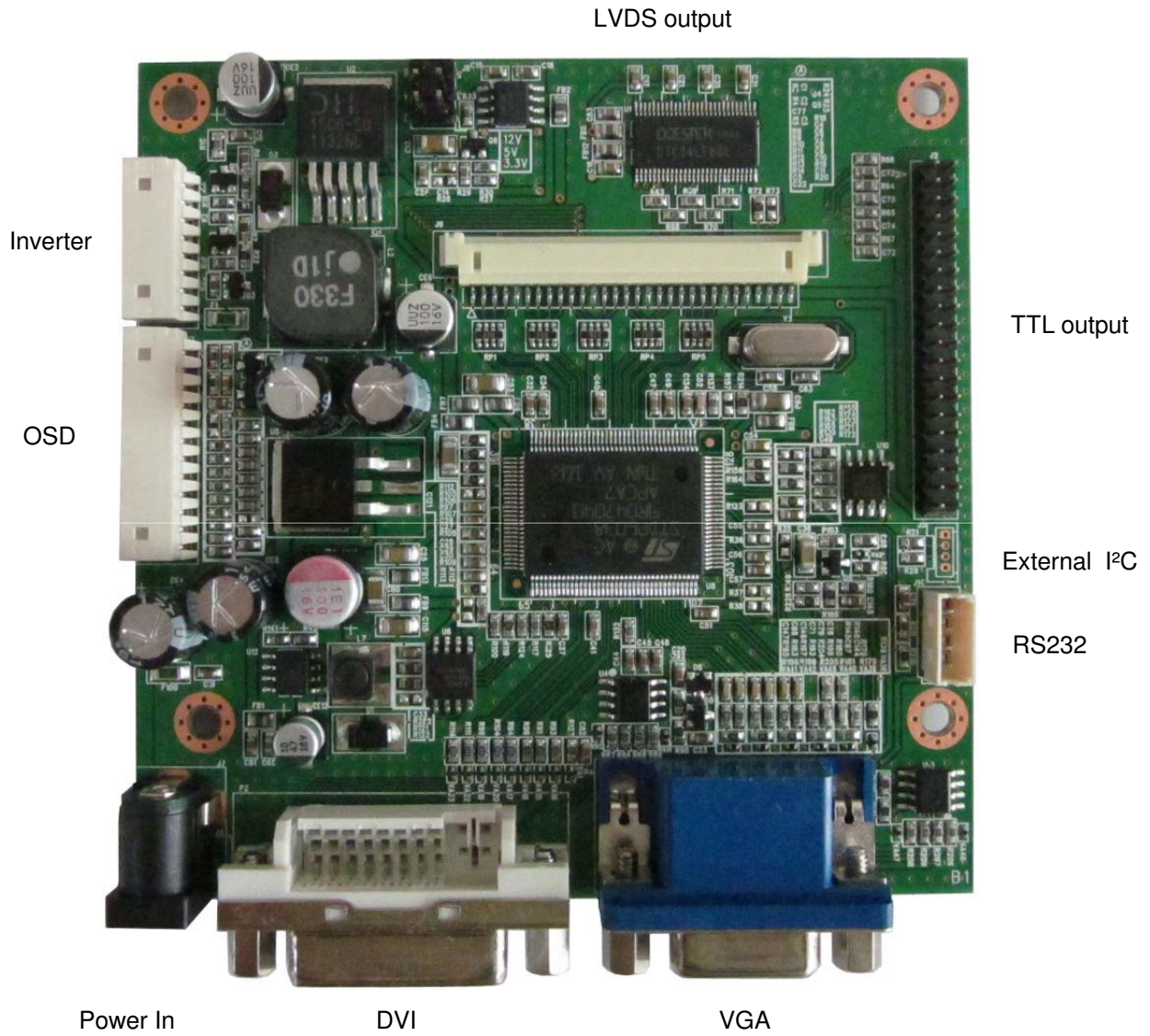

6. Connectors Information

6.1 Input Connectors

- Power Input Connector

Connector : DC12V Jack (J7)

Pin No.	Symbol	Description	Pin No.	Symbol	Description
1	Vin	VCC(DC12V)	2	Vin	Ground
3	Vin	Ground			

- Power Input Connector (Alternative)

Connector : Molex 5268-04 (J4)

Pin No.	Symbol	Description	Pin No.	Symbol	Description
1	Vin	+12V DC	2	Vin	+12V DC
3	Vin	Ground	4	Vin	Ground

- Backlight Connector :

Connector : Molex 53015-0810 (J1)

Pin No.	Symbol	Description	Pin No.	Symbol	Description
1	BRIGHT	Brightness Adjustment	5	GND	Ground
2	ON/OFF	Back-light On/Off	6	GND	Ground
3	GND	Ground	7	VCC	+12~24V DC
4	5VCC	+5V DC	8	VCC	+12~24V DC



- OSD, LED Interface Connector :

Input Connector : Molex 53015-1210 (J3)

Pin No.	Symbol	Pin No.	Symbol
1	LED RED	7	RIGHT
2	LED GREEN	8	LEFT
3	5VCC	9	DOWN
4	REMOTE	10	MENU
5	GND	11	SOURCE
6	POWER	12	UP

- Debug Connector :

Connector : Molex 53015-04 (J14)

Pin No.	Symbol	Description
1	GND	Ground
2	Rx	TxD
3	Tx	RxD
4	VCC	+5V DC

- External I2C Connector

Input Connector : Molex 53047-04 (J5)

Pin No.	Symbol	Description
1	Vcc	+5V
2	SDA	Serial Data
3	SCL	Serial Clock
4	GND	Ground

● DVI Input Connector

Connector : DVI-D (P2)

Pin No.	Symbol	Pin No.	Symbol	Pin No.	Symbol
1	T.M.D.S Data 2-	9	T.M.D.S Data 1-	17	T.M.D.S Data 0-
2	T.M.D.S Data 2+	10	T.M.D.S Data 1+	18	T.M.D.S Data 0+
3	T.M.D.S. Data2/4 Shield	11	T.M.D.S. Data1/3 Shield	19	T.M.D.S. Data 0/5 Shield
4	T.M.D.S Data 4-	12	T.M.D.S Data 3-	20	T.M.D.S Data 5-
5	T.M.D.S Data 4+	13	T.M.D.S Data 3+	21	T.M.D.S Data 5+
6	DDC Clock	14	+5V Power	22	T.M.D.S. Clock Shield
7	DDC Data	15	Ground	23	T.M.D.S Clock+
			(Return for +5V, H-Sync, and V-Sync)		
8	NC	16	Hot Plug Detect	24	T.M.D.S Clock-

● Analog RGB Input Connector

Connector : Mini D-Sub 15pin (P4)

Pin No.	Symbol	Description	Pin No.	Symbol	Description
1	RED	Red Input	9	N/C	No Connection
2	GREEN	Green Input	10	BLUE	Blue Input
3	BLUE	Blue Input	11	N/C	No Connection
4	N/C	No Connection	12	SDA	DDC Serial Data
5	GND	Ground	13	HSYNC	Horizontal Sync
6	RGND	Red Return	14	VSYNC	Vertical Sync
7	GGND	Green Return	15	SCL	DDC Data Clock
8	BGND	Blue Return			

6.2 Output Connectors

- LVDS Output Connector

Connector : Yeonho 12507WR-30 (J9)

Pin No.	Symbol	Pin No.	Symbol
1	TX0- E	16	TX1+ O
2	TX0+ E	17	GND
3	TX1- E	18	TX2- O
4	TX1+ E	19	TX2+ O
5	GND	20	TXCLK- O
6	TX2- E	21	TXCLK+ O
7	TX2+ E	22	TX3- O
8	TXCLK- E	23	TX3+ O
9	TXCLK+ E	24	GND
10	TX3- E	25	3.3V (LVDS option)
11	TX3+ E	26	GND
12	GND	27	VCC
13	TX0- O	28	VCC
14	TX0+ O	29	VCC
15	TX1- O	30	VCC

● TTL Output Connector :

Connector : 21570220100090 2*20P, S/T, 2.00MM,, (J2)

Pin No.	Symbol	Description	Pin No.	Symbol	Description
1	PWR	Panel Power	2	PWR	Panel Power
3	GND	Ground	4	DCLK	Clock Output
5	GND	Ground	6	VS	V-SYNC
7	HS	H-SYNC	8	DE	Data Enable
9	GND	Ground	10	R0	RED0
11	R1	RED1	12	GND	Ground
13	R2	RED2	14	R3	RED3
15	R4	RED4	16	R5	RED5
17	R6	RED6	18	R7	RED7
19	GND	Ground	20	G0	GREEN0
21	G1	GREEN1	22	GND	Ground
23	G2	GREEN2	24	G3	GREEN3
25	G4	GREEN4	26	G5	GREEN5
27	G6	GREEN6	28	G7	GREEN7
29	GND	Ground	30	B0	BLUE0
31	B1	BLUE1	32	GND	Ground
33	B2	BLUE2	34	B3	BLUE3
35	B4	BLUE4	36	B5	BLUE5
37	B6	BLUE6	38	B7	BLUE7
39	PWR	Panel Power	40	PWR	Panel Power

7. Reference Data

Video Input Timing;

Supported vertical refresh rates for each modes are as follows:

640 x 350	70Hz
640 x 400	70Hz
700 x 560	55~75Hz
720 x 350	70Hz
720 x 400	70Hz
640 x 480	60~75Hz
800 x 600	60~75Hz
1024 x 768	60~75Hz
1152 x 864	60~75Hz
1280 x 1024	60~75Hz
1280 x 768	60~75Hz
1366 x 768	60~75Hz
1440 x 900	60~75Hz
1600 x 1200	60~75Hz
1680 x 1050	60~75Hz
1920 x 1080	60Hz

Sync. : H/V Separated TTL, Composite Sync

● Electrical Parameters

Reference Poppy-O II, t_A 25 °C

Symbol	Description	Min	Type	Max	Unit
V_{DD}	DC Power Supply	11.2	12 ~24	24.8	V
$V_{i(RGB)}$	Video Input Signal (w.r.t. GND)	0.5	0.7	1.0	V_{PP}
f_S	Video Sample Rate			80	MHz
f_{HS}	Horizontal Sync. Frequency	30		60	KHz
f_{vs}	Vertical Sync Frequency	56		75	Hz
F_{SIH}	Sync Input High Level	2.5			V
V_{SIL}	Sync Input Low Level			0.8	VDC
I_{DD2}	Supply Current +12V (with LCD & Inverter)			3.5	A

Note 1. Power consumption measuring condition is 2 pixel check board pattern @ SXGA 75Hz and maximum brightness with Samsung LTM170E4 & inverter at t_A 25°C.

8. Supported Input Formats

8.1 Video Mode Support

The Poppy-O II series can support any video mode within the following input constraints:

- Signal sample frequency with the input $\leq 80\text{MHz}$
- Horizontal sync frequency between 30KHz and 80KHz

The modes are detected with the presentation of the input and previous alignments for setup are Automatically recalled. The emulation of a true multi-sync monitor is implemented.

The factory preset supported modes are as follows:

Mode	Resolution	Refresh rate	H-freq.	Pixel freq.	Remarks
VGA	640 x 350	70Hz	31.47KHz	25.175MHz	VESA Standard
VGA	720 x 400	59.940HZ	31.469KHZ	25.175MHZ	IBM VGA 3H
VGA	640 x 480	60Hz	31.5KHz	25.175MHz	Industry Standard
VGA	640 x 480	72Hz	37.9KHz	31.5MHz	VESA Standard
VGA	640 x 480	75HZ	37.5KHZ	31.5MHZ	VESA Standard
SVGA	800 x 600	60Hz	37.9KHz	40 MHz	VESA Guidelines
SVGA	800 x 600	72Hz	48.1KHz	50 MHz	VESA Standard
SVGA	800 x 600	75HZ	46.9KHZ	49.5MHZ	VESA Standard
XGA	1024 x 768	60Hz	48.4KHz	65 MHz	VESA Guidelines
XGA	1024 x 768	70Hz	56.5KHz	75 MHz	VESA Standard
XGA	1024 x 768	75HZ	60KHZ	78.75MHZ	VESA Standard
SXGA	1280 x 1024	60Hz	64KHZ	108 MHZ	VESA Standard
SXGA	1280 x 1024	75HZ	80KHZ	135 MHZ	VESA Standard
WXGA	1280 x 768	60~75Hz	47.7~65KHZ	80.14 MHZ	Not Standard
WXGA	1366 x 768	60~75Hz	47.7~65KHZ	80 MHZ	Not Standard
WSXGA	1440 x 900	60~75Hz	58KHZ	135 MHZ	Not Standard
WSXGA+	1680 x1050	60Hz	62KHZ	140 MHZ	Not Standard
UXGA	1600 x1200	60Hz	62KHZ	162 MHZ	Not Standard
FHD	1920 x1080	60Hz	69KHZ	138 MHZ	
WUXGA	1920 x1200	60Hz	69KHZ	154 MHZ	

Notes:

1. All mentioned modes are non-interlaced. The maximum and minimum frame rates are determined by the TFT-LCD.
2. Factory preset modes are overwritten by additional user alignments for automatic recall. The factory preset modes can be recalled at any time.



8.2 LCD Panel & I/O Support

Poppy-O II is an advanced and general application for a TFT-LCD Monitor Control board. Therefore, the application of this board is not limited to panel manufacturers or models. Furthermore, this board operates with LVDS interface panel ranging from VGA to WUXGA that can be driven with three or less timing signals. The usual timing signals to a panel are H-sync, V-sync and Data Enable.

For backlight intensity control mechanism, a built-in DC dimming drive signal is installed into the CCFL Inverter or LED driver control port.

The CCFL inverter & LED driver DC power, generally 12V DC, is attached to the same port. Users can design their own key pad board by using OSD & power tact switch as well as a two-color LED.

On/off power switch and OSD input signal are detected and executed by the micro controller.

9. OSD (On Screen Display)

9.1 OSD Board Dimension

9.1.1 OSD Board with 6 Buttons

Part number : SGLM0000600

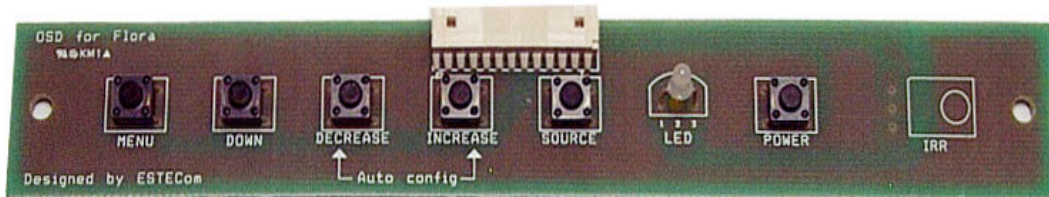

Menu(Enter)/Down(Auto Config.)/Decrease(Left)/Increase(Right)/Source Select(Exit)/Power

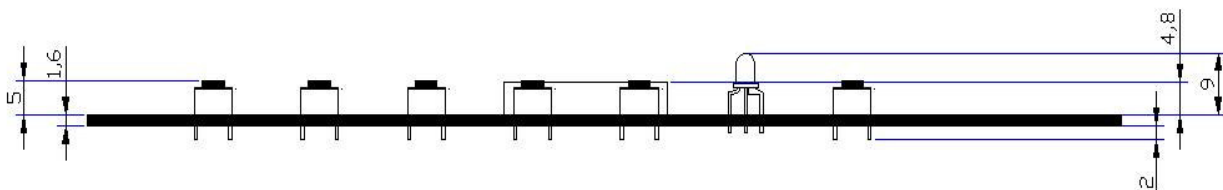
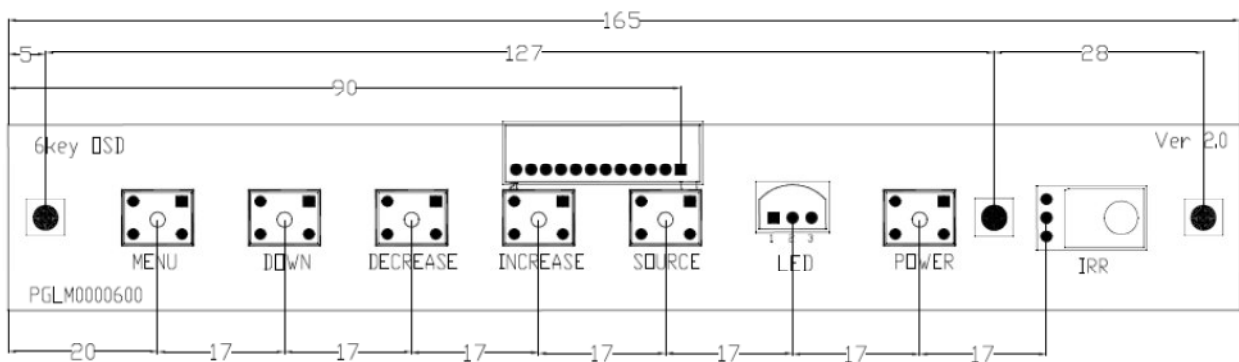

OSD Key Description

- MENU : Menu Key
- DOWN (Auto) : Down Key (HOT Key : Auto Config.)
- DECREASE : Decrease Key, Left Key
- INCREASE : Increase Key, Right Key
- SOURCE/EXIT : Source Select & Exit HOT Key : Source Select [Analog – DVI]



9.2 OSD menu enables user to manipulate the image & settings

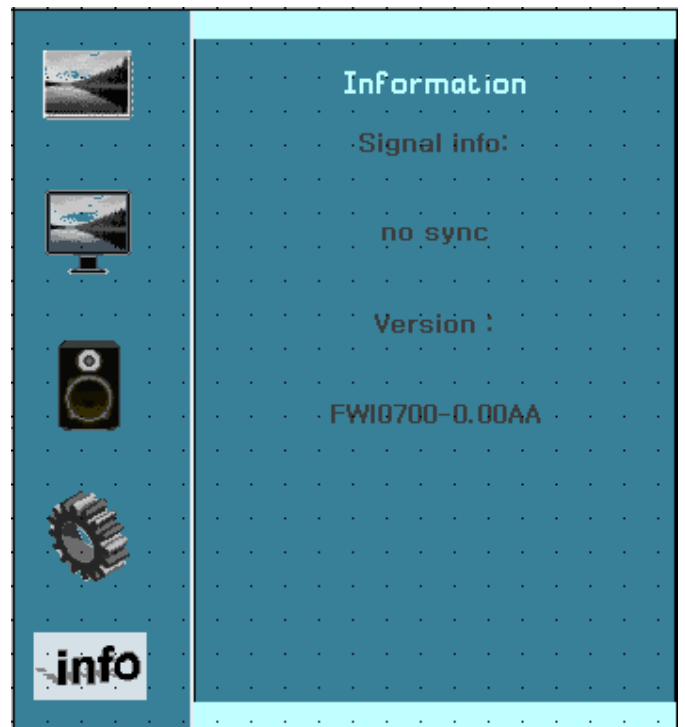
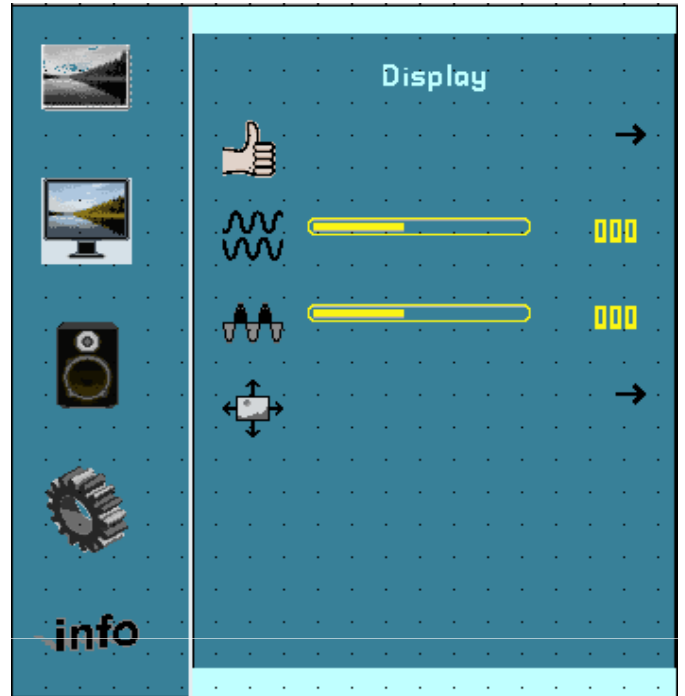
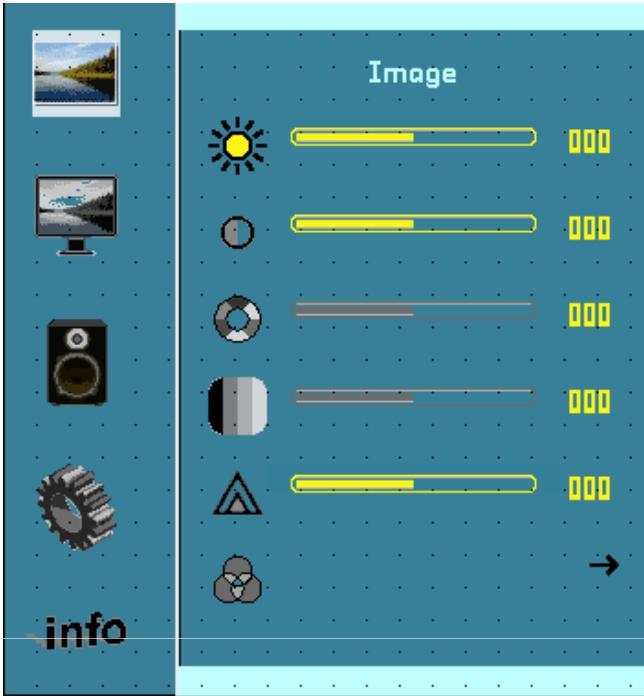

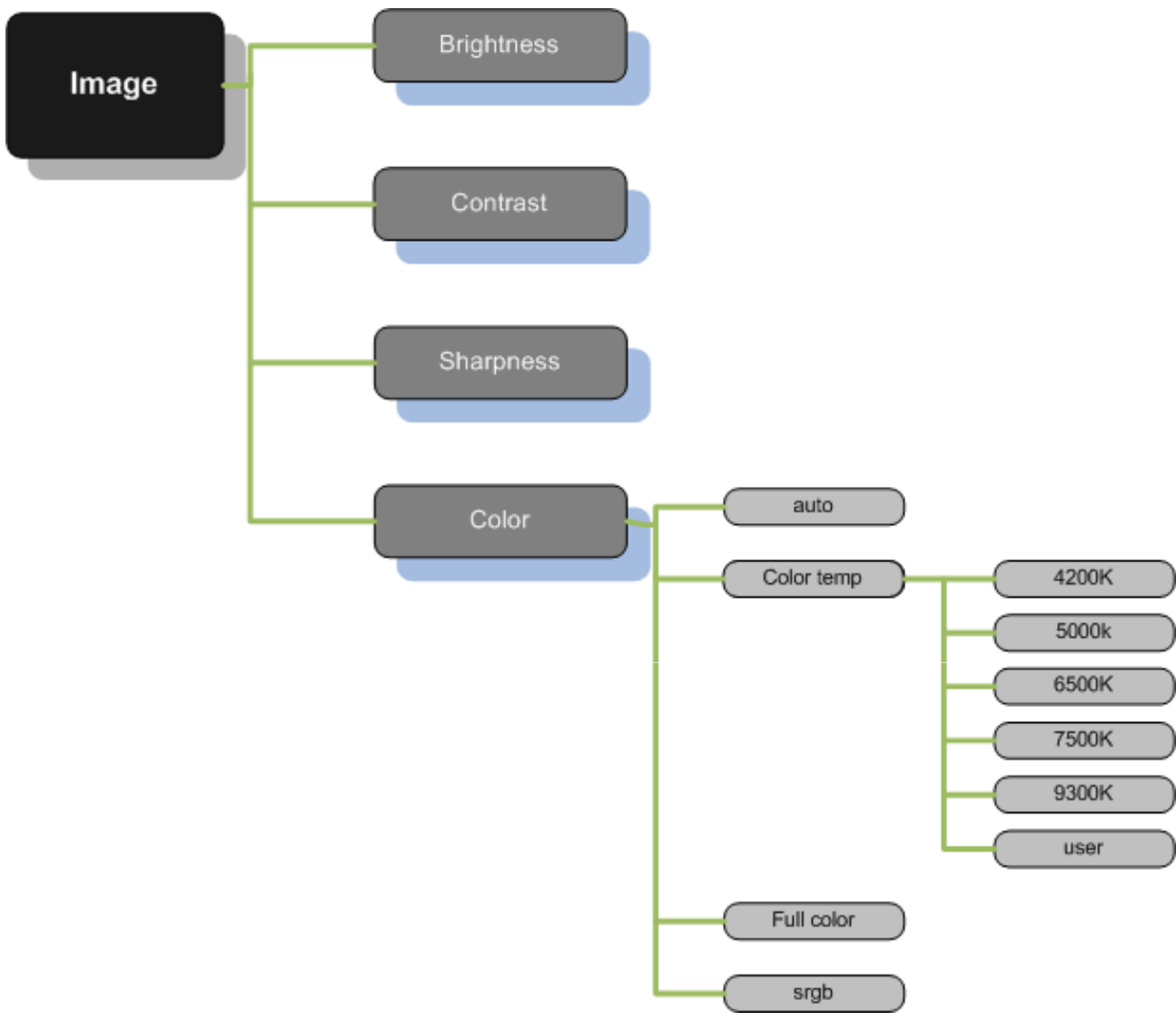

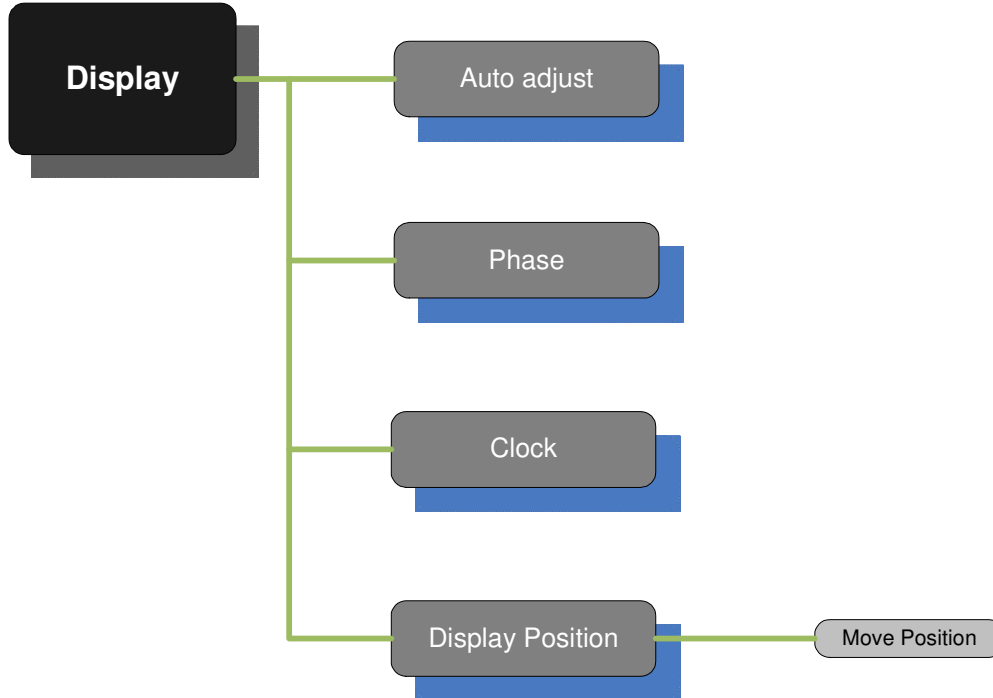

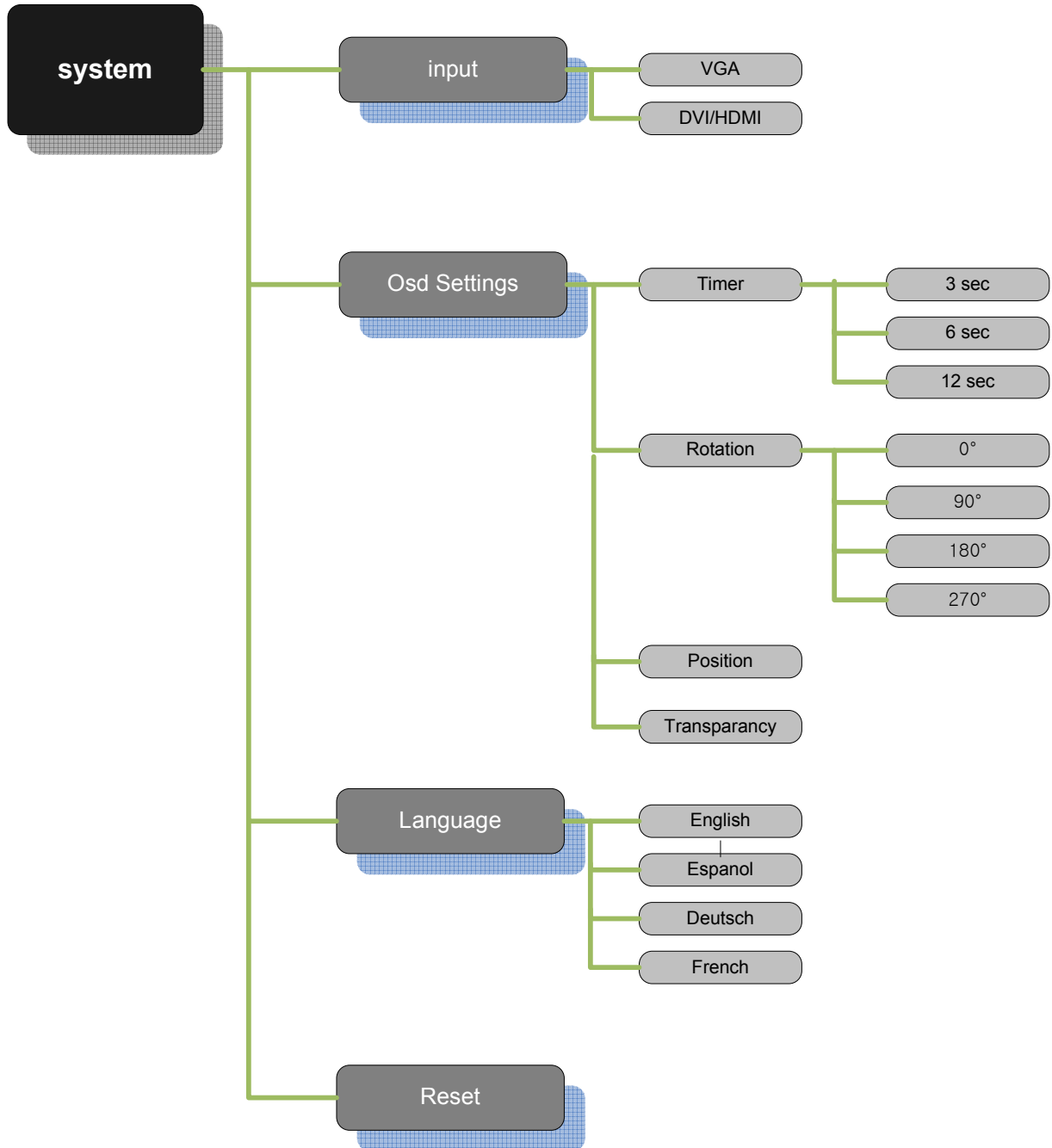



10. RS-232 communication protocol.

10.1 Purpose

- RS232C control from PC can be used on Poppy-I B'd

10.2 Requirements

- ESTECOM Standard programming Cable or public RS-232 circuit tool.
- Communication program such as Hyper terminal or ESECOM COMControl program

10.3 General description

10.3.1 Command Length

- LENGTH : 8 bytes (OSD Key : 4 bytes)

10.3.2 Check Sum

- 8 Byte SUM : 100 (OSD key 4byte SUM)

10.3.3 Baud rate

- Must be set 115200 rate



10.4 Command sequence definition of OSD Key functions

10.4.1 Menu

04 21 00 DB

10.4.2 Down

04 21 01 DA

10.4.3 Up

04 21 02 D9

10.4.4 Decrease

04 21 03 D8

10.4.5 Increase

04 21 04 D7

10.4.6 Source

04 21 05 D6

10.4.7 Power

04 21 06 D5

**10.5 Set Command sequence definition of items****1) Set Brightness to 100 / 80**

08 22 00 00 00 00 64 72

08 22 00 00 00 00 50 86

2) Set Contrast to 100 / 40

08 22 01 00 00 00 64 71

08 22 01 00 00 00 28 AD

3) Set sharpness to 3 / 4 / -4 / 0

08 22 03 00 00 00 07 CC

08 22 03 00 00 00 08 CB

08 22 03 00 00 00 00 D3

08 22 03 00 00 00 04 CF

4) Input Source change DVI / VGA

08 22 05 00 00 00 00 D1

08 22 06 00 00 00 00 D0

5) Do an Auto adjust

08 22 07 00 00 00 00 CF

6) Do Auto color adjust

08 22 08 00 00 00 00 CE

7) Set Volume 100 / 50

08 22 09 00 00 00 64 69

08 22 09 00 00 00 32 9B

8) Set Mute On / Off

08 22 0A 00 00 00 01 CB

08 22 0A 00 00 00 00 CC

9) Set Phase to 100 / 20

08 22 0B 00 00 00 64 67

08 22 0B 00 00 00 14 B7

**10) Set Color Temp to 4200 (5000/6500/7500/9300/user)**

08 22 04 00 00 00 02 D0 : 4200

08 22 04 00 00 00 03 CF : 5000

08 22 04 00 00 00 04 CE : 6500

08 22 04 00 00 00 05 CD : 7500

08 22 04 00 00 00 06 CC : 9300

08 22 04 00 00 00 07 CB : user

11) Set Red Color to 50

08 22 0E 00 00 00 32 96

12) Set Green Color to 20

08 22 0F 00 00 00 14 B3

13) Set Blue Color to 80

08 22 10 00 00 00 50 76

14) Do a Reset

08 22 11 00 00 00 00 C5

15) Set Color Space to full color / sRGB

08 22 12 00 00 00 00 C4

08 22 13 00 00 00 02 C1

16) Set Power OFF

08 22 FE 00 00 00 00 D8

17) Set Power ON

08 22 FD 00 00 00 00 D9

**10.6 Get Command sequence definition of items****1) Get Input Status**

04 21 07 D4

2) Get BL Brightness

04 21 08 D3

3) Get Contrast

04 21 09 D2

4) Get Sharpness

04 21 0A D1

5) Get Color Temp

04 21 0B D0 (1 : USER 2 : 4200K 3 : 5000K 4 : 6500K 5 : 7500K 6 : 9300K)

6) Get Red

04 21 0C CF

7) Get Green

04 21 0D CE

8) Get Blue

04 21 0E CD

9) Get Volume

04 21 0F CC

10) Get Phase

04 21 10 CB

11) Get Clock

04 21 11 CA

12) Get Display Horizontal Position

04 21 12 C9

13) Get Display Vertical Position

04 21 13 C8

14) Get MUTE

04 21 14 C7 (0 : mute off 1 : mute on)



15) Get Color Space

04 21 15 C6

(0:full color 2:srgb)

16) Get Power Status (RX to HEX)

04 21 16 C5

(On 10 0D 50 6F 77 65 72 20 3A 20 4F 4E 00 00 00 BF 03 0C F1

Off 9A 0D 50 6F 77 E5 F2 A0 3A 20 FF FF FF FF FF FF FF FF FF FF 82 FE 80 00 00 DC 83 0C F1

9A 8D 50 6F 77 E5 F2 A0 BA 20 FF FF FF FF FF FF FF FF FF FF 82 FE 80 80 00 DC 83 8C F1

9A 8D D0 6F 77 65 F2 A0 BA A0 FF FF FF FF FF FF FF FF FF FF 02 FE 80 80 80 DC 83 8C F1

1A 0D 50 6F 77 E5 F2 A0 3A 20 FF FF FF FF FF FF FF FF FF FF 82 FE 00 00 00 DC 03 0C F1

1A 0D 50 6F 77 E5 F2 A0 3A 20 FF FF FF FF FF FF FF FF FF FF 82 FE 00 00 00 DC 83 0C F1

1A 0D 50 EF 77 E5 F2 20 3A 20 FF FF FF FF FF FF FF FF FF FF 82 FE 00 00 00 DC 03 0C F1)