

CV-W124/P2102 Series

24" TFT-LCD Modular Panel PC with 8th Gen. Intel® Core™ U Series Processor



- 24" Full HD TFT-LCD with Resistive 5-wire Touch / Projected Capacitive Touch
- Onboard 8th Generation Intel® Core™ U Series Processor
- 2x DDR4 SO-DIMM Socket, Supports Up to 2400MHz, 64GB
- Supports Triple Independent Display
- Integrated USB 3.2 Gen 2 supports up to 10Gbps
- M.2 E Key Socket for Wireless Module or Intel CRF Module
- Supports Ignition Sensing Function (IGN) (with optional CFM module)
- Supports 2x PoE+ Function (with optional CFM module)
- Designed with Rugged Aluminum Die-casting Front Bezel
- True Flat IP65 Compliant Front Panel Protection
- Supports Panel / VESA / Rack Mounting

Overview

The CV-W124/P2102 Series is a 24" TFT-LCD panel PC with Intel® 8th generation Core™ U Series Processor and is suitable for the high-performance requirement in factory and machine automation applications. The processor brings outstanding computing performance boost up to 84% at a TDP of 15 watts, compared to 6th generation Intel® Core™ U series. To enable faster responsiveness and deal with multi tasks with ease, the panel PC is equipped with two DDR4 2400 SODIMM sockets for up to 64 GB memory.

With its slim design, the CV-W124/P2102 Series offers extensive I/O to fulfill different connectivities and can easily fit into almost any space limited environment. For wireless connectivity, the CV-W124/P2102 Series has 1x M.2 2230 E key and 2x full-size Mini-PCIe expansions which can be installed various add-on cards to enable Wi-Fi, 3G, and LTE communication. Besides, the CV-W124/P2102 Series supports Control Function Module (CFM) Technology to install optional CFM modules for increasing power over ethernet and power ignition sensing functions according to user's specific applications. Featuring rigorous industrial protections, wide range operating temperature, IP65 dust/waterproof front panel, and wide range DC power input (9 to 48VDC), the CV-W124/P2102 Series is appropriate for harsh environments and critical industrial applications.

Furthermore, the CV-W124/P2102 Series supports Cincoze patented Convertible Display System (CDS) technology, allowing users to replace display module or computer module on-site easily and thereby reducing maintenance costs and downtime.

Highlights



4X Cores

High Performance Per Watt

Powered by 8th generation Intel® Core™ U series processor (up to 4 cores, 4.10 GHz) at a TDP of only 15W, the CV-W124/P2102 can fulfill a variety of applications that require high-performance computing and low power budget simultaneously.

**Thickness
67 mm**



Slim Design with Multiple Functions

The CV-W124/P2102 is designed at only 67 mm height and provides a wall-mount kit for easy installation in any space limited environment. Furthermore, a variety of I/O, 2x 2.5" SATA 3.0 drive bays, and M.2/mPCIe expansions are also available to fulfill multiple applications.



CDS
Convertible Display System

Patented CDS Technology

Thanks to Cincoze patented Convertible Display System (CDS) technology, the CV-W124/P2102 not only makes maintenance easier but also provides upgradability whenever requested.

CV-W124 Series Specifications

| Model Name | CV-W124R | CV-W124C | CV-W124G |
|-------------------------|---|---|----------------|
| Display | | | |
| LCD Size | • 24" (16:9) | | |
| Max. Resolution | • 1920 x 1080 | | |
| Brightness (cd/m2) | • 300 | | |
| Contrast Ratio | • 5000 : 1 | | |
| LCD Color | • 16.7M | | |
| Pixel Pitch (mm) | • 0.27675 (H) x 0.27675 (V) | | |
| Viewing Angle (H-V) | • 178 / 178 | | |
| Backlight MTBF | • 50,000 hrs (LED Backlight) | | |
| Touch Screen | | | |
| Touch Type | • Resistive 5-wire | • Projected Capacitive | • Glass Screen |
| Physical | | | |
| Dimension (W x D x H) | • 605 x 373 x 63.2 mm | | |
| Weight Information | • 6.92 kg | • 6.64 kg | |
| Mechanical Construction | • Die-Casting Flat Surface | | |
| Environment | | | |
| Front Panel Protection | • IP 65 Compliant | | |
| Operating Temperature | • Ambient with Air flow: -20°C to 70°C (with Industrial Grade Peripherals) | | |
| Storage Temperature | • -30°C to 80°C | | |
| Relative Humidity | • 80% RH @ 50°C (Non-condensing) | | |
| Vibration | | • Operating, 1 Grms, 10-500 Hz, 3 Axes (w/P2012E only, according to IEC60068-2-6) | |
| EMC | • CE, UKCA, FCC, ICES-003 Class A | | |
| EMI | <ul style="list-style-type: none"> • CISPR 32 Conducted & Radiated: Class A • EN/BS EN 55032 Conducted & Radiated: Class A • EN/BS EN IEC 61000-3-2 Harmonic current emissions: Class A • EN/BS EN61000-3-3 Voltage fluctuations & flicker • FCC 47 CFR Part 15B, ICES-003 Conducted & Radiated: Class A | | |
| EMS | <ul style="list-style-type: none"> • EN/IEC 61000-4-2 ESD: Contact: 4 kV; Air: 8 kV • EN/IEC 61000-4-3 RS: 80 MHz to 1000 MHz: 3 V/m • EN/IEC 61000-4-4 EFT: AC Power: 1 kV; DC Power: 0.5 kV; Signal: 0.5 kV • EN/IEC 61000-4-5 Surges: AC Power: 2 kV; Signal: 1 kV • EN/IEC 61000-4-6 CS: 3V • EN/IEC 61000-4-8 PFMF: 50 Hz, 1A/m • EN/IEC 61000-4-11 Voltage Dips & Voltage Interruptions: 0.5 cycles at 50 Hz | | |
| Safety | • UL, cUL, CB, IEC, EN 62368-1 | | |

P2102 Series Specifications

| Model Name | P2102 | P2102E |
|---|---|--|
| System | | |
| Processor | <ul style="list-style-type: none"> Onboard 8th Intel® Core™ U Processors (Whiskey Lake) <ul style="list-style-type: none"> Intel® Core™ i5-8365UE Quad Core Processor (6M Cache, up to 4.10 GHz) Intel® Core™ i3-8145UE Dual Core Processor (4M Cache, up to 3.90 GHz) TDP: 15 W | |
| Memory | <ul style="list-style-type: none"> 2x DDR4 2400 MHz 260-Pin SO-DIMM Socket Support Un-buffered and Non-ECC Type up to 64 GB | |
| Graphics | | |
| Graphics Engine | <ul style="list-style-type: none"> Integrated Intel® UHD Graphics 620 | |
| Maximum Display Output | <ul style="list-style-type: none"> Supports Triple Independent Display | |
| CDS | <ul style="list-style-type: none"> 1x CDS Connector for Cincoze Display Module | |
| VGA | <ul style="list-style-type: none"> 1x VGA Connector(1920 x 1200 @60Hz) | |
| DP | <ul style="list-style-type: none"> 1x DisplayPort Connector (4096 x 2304 @ 60Hz, According to CPU Specifications) * Verified maximum resolution: 3840 x2160 @ 60Hz | |
| Audio | | |
| Audio Codec | <ul style="list-style-type: none"> Realtek® ALC888, High Definition Audio | |
| Line-out | <ul style="list-style-type: none"> 1x Line-out, Phone Jack 3.5mm | |
| Mic-in | <ul style="list-style-type: none"> 1x Mic-in, Phone Jack 3.5mm | |
| I/O | | |
| LAN | <ul style="list-style-type: none"> 2x GbE LAN (Supports WoL, Teaming, Jumbo Frame & PXE), RJ45 <ul style="list-style-type: none"> GbE1: Intel® I219LM GbE2: Intel® I210 | |
| USB | <ul style="list-style-type: none"> 3x USB 3.2 Gen2 (Type A), 2x USB 2.0 (Type A) | |
| Serial Port | <ul style="list-style-type: none"> 4x RS-232/422/485 with Auto Flow Control Support 5V/12V, DB9 | |
| DIO | <ul style="list-style-type: none"> 16x Isolated Digital I/O (8in/8out), 20-Pin Terminal Block | |
| Storage | | |
| SSD/HDD | <ul style="list-style-type: none"> 2x 2.5" HDD/SSD Drive Bay (SATA 3.0), Supports RAID 0/1 | |
| Expansion | | |
| Mini PCI Express | <ul style="list-style-type: none"> 2x Full-size Mini-PCIe Sockets | |
| PCI Express | | <ul style="list-style-type: none"> 1x PCI or 1x PCIe x4 Expansion slot with Optional Riser Card * Supports maximum dimensions of add-on card (H x L) : 111 x 169mm |
| M.2 E Key Socket | <ul style="list-style-type: none"> 1x M.2 2230 E Key Socket for Wireless Module, Supports Intel CRF Module | |
| SIM Socket | <ul style="list-style-type: none"> 1x Front Accessible SIM Socket | |
| Universal Bracket | | <ul style="list-style-type: none"> 2x Universal I/O Bracket |
| CFM (Control Function Module) Interface | <ul style="list-style-type: none"> 2x CFM Interface for optional IGN or PoE Module Expansion | |
| CDS (Convertible Display System) Technology | <ul style="list-style-type: none"> 1x Convertible Display System (CDS) Interface | |

| | | |
|-------------------------------------|---|---|
| Other Function | | |
| Clear CMOS Switch | • 1 x Clear CMOS Switch | |
| Instant Reboot | • Support 0.2sec Instant Reboot technology | |
| Watchdog Timer | • Software Programmable Supports 256 Levels System Reset | |
| Internal Speaker | • AMP 2W + 2W | |
| OSD Function | • LCD On/Off, Brightness Up, Brightness Down | |
| Reset Button | • 1x Reset Button | |
| Power | | |
| Power Button | • 1x ATX Power On/Off Switch | |
| Power Mode Switch | • 1x AT/ATX Mode Switch | |
| Power Input | • 1x 3-pin Terminal Block Connector with Power Input 9~48VDC | |
| Power Adapter (Optional) | • 1x Optional AC/DC 12V/5A, 60W or 24V/5A 120W | |
| Remote Power On/Off | • 1x Remote Power On/Off Connector, 2-pin Terminal Block | |
| Physical | | |
| Dimension(W x D x H) | • 254.5 x 190 x 41.5mm | • 254.5 x 190 x 61 mm |
| Weight Information | • 2.2 kg | • 2.7 kg |
| Mechanical Construction | • Extruded Aluminum with Heavy Duty Metal | |
| Mounting | • Wall / VESA / CDS / DIN Rail | |
| Physical Design | • Fanless Design • Jumper-less Design | |
| Reliability & Protection | | |
| Reverse Power Input | • Yes | |
| Over Voltage Protection | • Protection Range: 51~58V • Protection Type: shut down operating voltage, re-power on at the present level to recover | |
| Over Current Protection | • 15A | |
| CMOS Battery Backup | • SuperCap Integrated for CMOS Battery Maintenance-free Operation | |
| MTBF | • 231,243 hours | |
| Operating System | | |
| Microsoft® Windows® | • Windows®10 | |
| Linux | • Supports by project | |
| Environment | | |
| Operating Temperature | • Ambient with Air Flow: -40°C to 70°C (with Extended Temperature Peripherals) | |
| Storage Temperature | • -40°C to 70°C | |
| Relative humidity | • 95% RH @ 70°C (Non-condensing) | |
| Shock | • Operating, 50 Grms, Half-sine 11ms Duration (w/ SSD, according to IEC60068-2-27) | |
| Vibration | • Operating, 5 Grms, 5-500 Hz, 3 Axes (w/ SSD, according to IEC60068-2-64) | • Operating, 5 Grms, 5-500 Hz, 3 Axes (w/ SSD, according to IEC60068-2-64) • Operating, 1 Grms, 10-500 Hz, 3 Axes (w/ CV-W124 only, according to IEC60068-2-6) |
| EMC | • CE, UKCA, FCC, ICES-003 Class A | |

| | |
|-----------------|---|
| EMI | <ul style="list-style-type: none"> • CISPR 32 Conducted & Radiated: Class A • EN/BS EN 55032 Conducted & Radiated: Class A • EN/BS EN IEC 61000-3-2 Harmonic current emissions: Class A • EN/BS EN61000-3-3 Voltage fluctuations & flicker • FCC 47 CFR Part 15B, ICES-003 Conducted & Radiated: Class A |
| EMS | <ul style="list-style-type: none"> • EN/IEC 61000-4-2 ESD: Contact: 4 kV; Air: 8 kV • EN/IEC 61000-4-3 RS: 80 MHz to 1000 MHz: 3 V/m • EN/IEC 61000-4-4 EFT: AC Power: 1 kV; DC Power: 0.5 kV; Signal: 0.5 kV • EN/IEC 61000-4-5 Surges: AC Power: 2 kV; Signal: 1 kV • EN/IEC 61000-4-6 CS: 3V • EN/IEC 61000-4-8 PFMF: 50 Hz, 1A/m • EN/IEC 61000-4-11 Voltage Dips & Voltage Interruptions: 0.5 cycles at 50 Hz |
| Safety | <ul style="list-style-type: none"> • UL, cUL, CB, IEC, EN62368-1 |
| Fire Protection | <ul style="list-style-type: none"> • EN 45545-2 |

CV-W124/P2102 External Layout

Front I/O

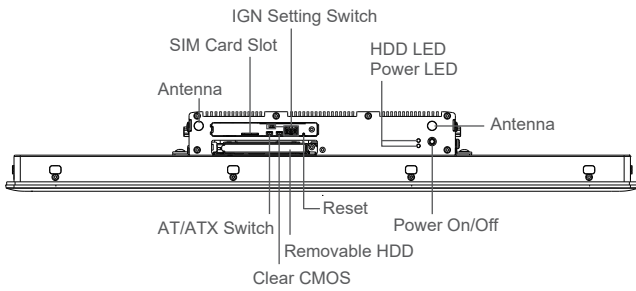

Rear I/O

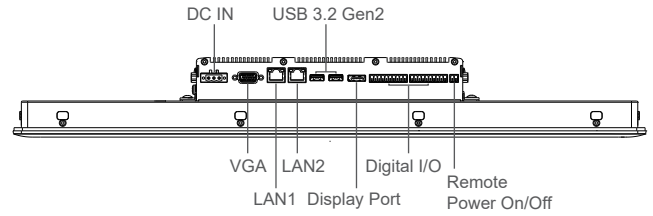

Left I/O

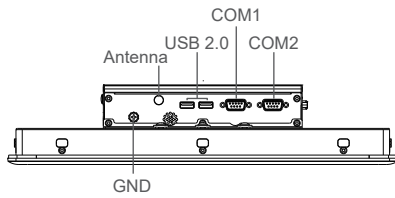

Right I/O

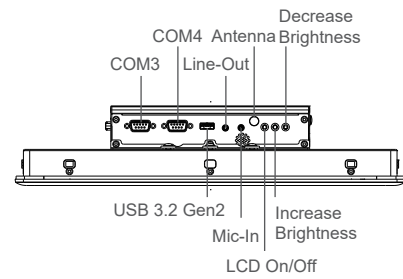

CV-W124/P2102E External Layout

Front I/O

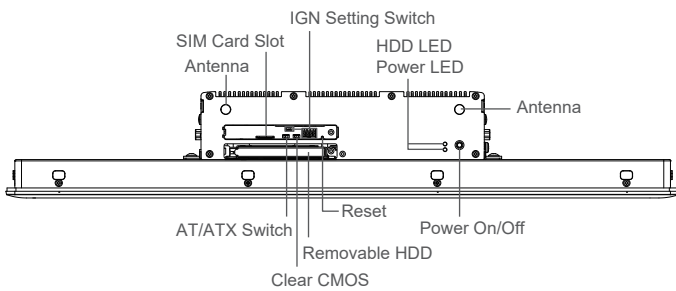

Rear I/O

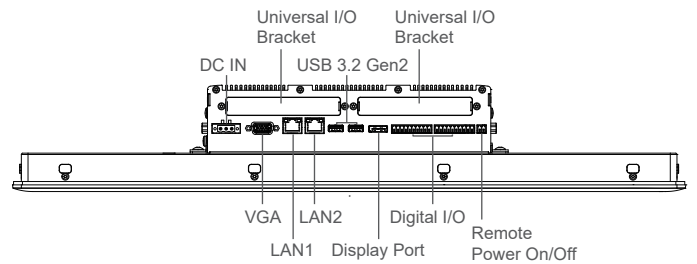

Left I/O

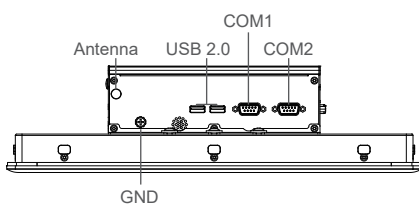

Right I/O

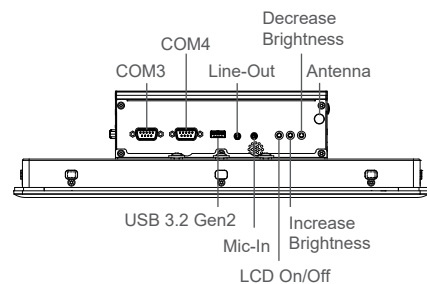

CV-W124/P2102 Dimensions

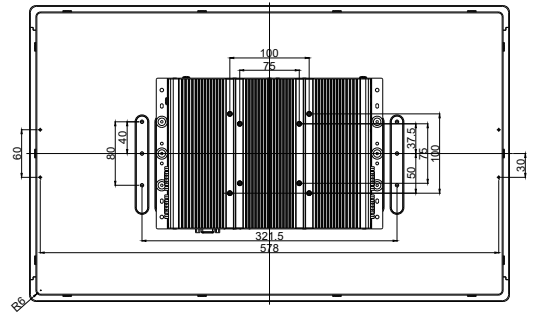
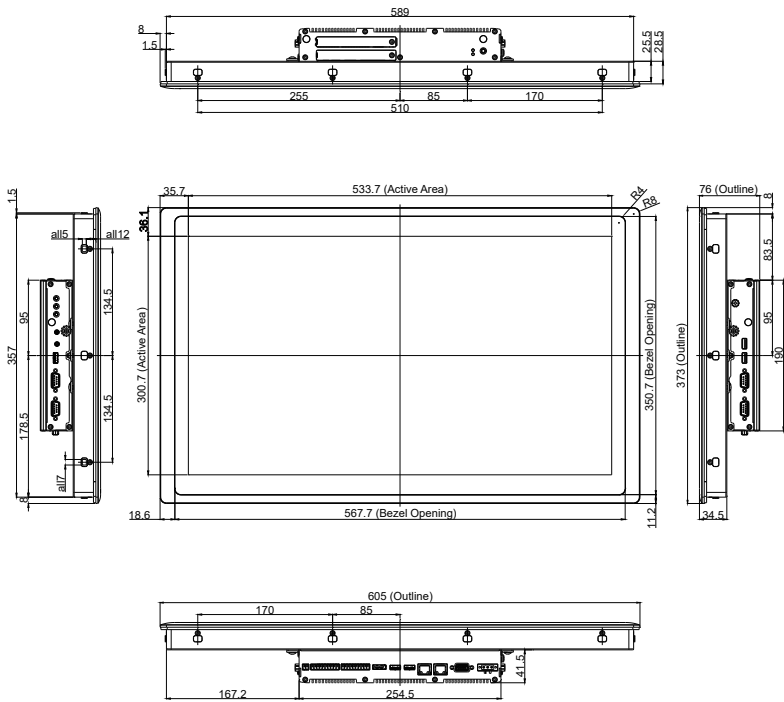

5.5 (Max. Wall Thickness)

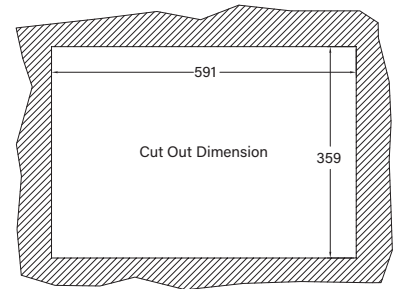

CV-W124/P2102E Dimensions

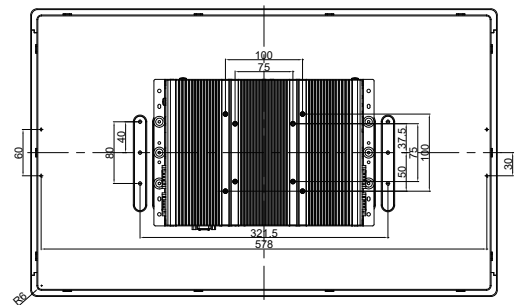
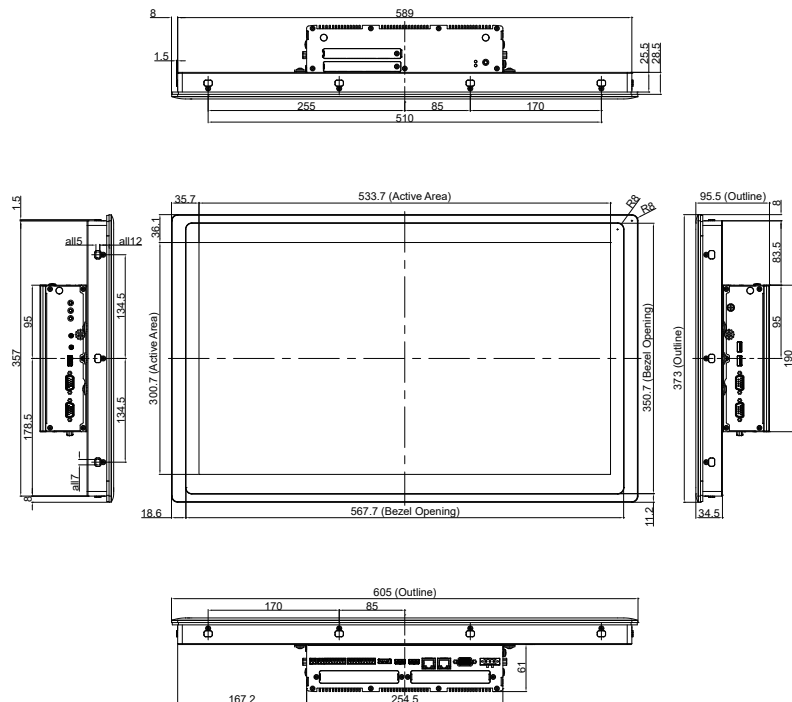

5.5 (Max. Wall Thickness)

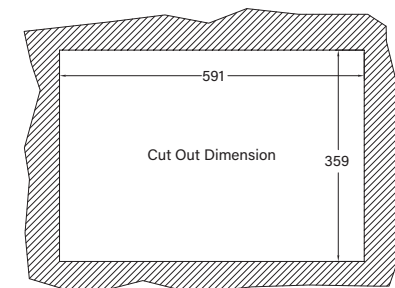

Unit: mm

Ordering Information

Available Models

| Model No. | Description |
|----------------------------|--|
| CV-W124R-R10/P2102-i5-R10 | 24" Full HD TFT-LCD Modular Panel PC with 8th Gen. Intel Core i5-8365UE Quad Core Processor and Resistive Touch |
| CV-W124R-R10/P2102E-i5-R10 | 24" Full HD TFT-LCD Modular and Expandable Panel PC with 8th Gen. Intel Core i5-8365UE Quad Core Processor and Resistive Touch |
| CV-W124C-R11/P2102-i5-R10 | 24" Full HD TFT-LCD Modular Panel PC with 8th Gen. Intel Core i5-8365UE Quad Core Processor and P-Cap. Touch |
| CV-W124C-R11/P2102E-i5-R10 | 24" Full HD TFT-LCD Modular and Expandable Panel PC with 8th Gen. Intel Core i5-8365UE Quad Core Processor and P-Cap. Touch |
| CV-W124G-R10/P2102-i5-R10 | 24" Full HD TFT-LCD Modular Panel PC with 8th Gen. Intel Core i5-8365UE Quad Core Processor and Glass Only |
| CV-W124G-R10/P2102E-i5-R10 | 24" Full HD TFT-LCD Modular Panel PC with 8th Gen. Intel Core i3-8145UE Dual Core Processor and Glass Only |
| CV-W124R-R10/P2102-i3-R10 | 24" Full HD TFT-LCD Modular Panel PC with 8th Gen. Intel Core i3-8145UE Dual Core Processor and Resistive Touch |
| CV-W124R-R10/P2102E-i3-R10 | 24" Full HD TFT-LCD Modular and Expandable Panel PC with 8th Gen. Intel Core i3-8145UE Dual Core Processor and Resistive Touch |
| CV-W124C-R11/P2102-i3-R10 | 24" Full HD TFT-LCD Modular Panel PC with 8th Gen. Intel Core i3-8145UE Dual Core Processor and P-Cap. Touch |
| CV-W124C-R11/P2102E-i3-R10 | 24" Full HD TFT-LCD Modular and Expandable Panel PC with 8th Gen. Intel Core i3-8145UE Dual Core Processor and P-Cap. Touch |
| CV-W124G-R10/P2102-i3-R10 | 24" Full HD TFT-LCD Modular Panel PC with 8th Gen. Intel Core i3-8145UE Dual Core Processor and Glass Only |
| CV-W124G-R10/P2102E-i3-R10 | 24" Full HD TFT-LCD Modular and Expandable Panel PC with 8th Gen. Intel Core i3-8145UE Dual Core Processor and Glass Only |

Model Configuration

| | CV-W124R | CV-W124C | CV-W124G | P2102(i3/i5) | P2102E(i3/i5) |
|-----------------|----------|----------|----------|--------------|---------------|
| CV-W124R/P2102 | V | -- | -- | V | -- |
| CV-W124C/P2102 | -- | V | -- | V | -- |
| CV-W124G/P2102 | -- | -- | V | V | -- |
| CV-W124R/P2102E | V | -- | -- | -- | V |
| CV-W124C/P2102E | -- | V | -- | -- | V |
| CV-W124G/P2102E | -- | -- | V | -- | V |

V : Compatible

Package Checklist





| | |
|---|--|
| • CV-W124/P2102 Series Panel PC x 1 | • Power Terminal Block Connector (Female) x 1 |
| • Panel Mounting Kit x 1 | • Screw Pack x 5 |
| • DIO Terminal Block Connector (Female) x 2 | • Remote Power On/Off Terminal Block Connector x 1 |
| • PCI / PCIe Card Installation Kit x 1(For P2102E only) | • Thermal Pad (for CPU Thermal Block) x 1 |

Optional Modules and Accessories

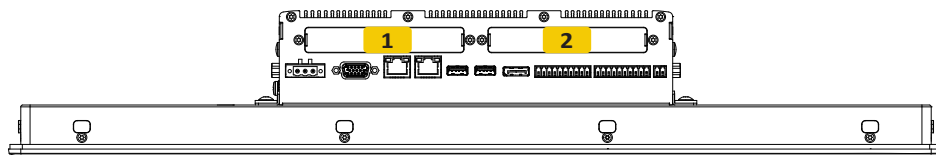
| Model No. | Description |
|-------------------|---|
| MEC-COM-M212-DB9 | Mini-PCIe Module with 2x RS-232 Serial Ports, 1x Standard DB9 Cable (For P2102E Only) |
| MEC-COM-M334-TDB9 | Mini-PCIe Module with 4x RS-232/422/485 Serial Ports, 2x Thin DB9 Cable (For P2102E Only) |
| MEC-LAN-M102-30 | Mini-PCIe Module with 2x LAN Ports, 2x 30cm (For P2102E Only) |
| MEC-USB-M102-30 | Mini-PCIe Module with 2x USB 3.2 Gen1 Ports (For P2102E Only) |
| CFM-IGN101 | CFM Module with Power Ignition Sensing Control Function, 12V/24V Selectable |
| CFM-PoE04 | PoE Control Function Module, Individual Port 25.5W (For P2102 only) |
| CFM-PoE05 | PoE Control Function Module, Individual Port 25.5W (For P2102E only) |
| RC-E4-02 | Riser Card with 1x PCIe4 Slot (For P2102E only) |
| RC-PI-02 | Riser Card with 1x PCI Slot (For P2102E only) |
| UB1203 | Universal Bracket with 2x DB9 Cutout (For P2102E only) |
| UB1211 | Universal Bracket with 2x RJ45 Cutout (For P2102E only) |
| UB1214 | Universal Bracket with 2x USB Cutout (For P2102E only) |
| URM01 | Universal 19" Rack Mount Kit for Industrial Panel PC & Industrial Monitor |
| GST120A24-CIN | Adapter AC/DC 24V 5A 120W, GST120A24-CIN, wide temp(-30°C ~ +70°C), level VI |
| GST60A12-CIN1 | Adapter AC/DC 12V 5A 60W, GST60A12-CIN1, wide temp(-30°C ~ +70°C) |
| SL2-SL3 | US 2 heads power cord, US B type to IEC C13,SVT 18AWG/3C Black 1.8M |
| SL6-SL3 | EU 2 heads power cord, EU G type to IEC C13,H05VV-F 0.75mm2/3G Black 1.8M |
| QP026-SL3 | UK 2 heads power cord, UK I type to IEC C13,H05VV-F 0.75mm2/3G Black 1.8M |

Optional Module Configuration (For P2102E only)



| Model No. | Description | 1 | 2 |
|---|---|---|---|
|  MEC-COM-M212-TDB9/UB1203 | Mini-PCIe Module with 2x COM Ports, 1x Standard DB9 Cable, 2x Universal Bracket each with 1x DB9 Cutout | V | V |
|  MEC-COM-M334-TDB9/UB1203 | Mini-PCIe Module with 4x RS-232/422/485 Serial Ports | V | V |
|  MEC-LAN-M102-30/UB1211 | Mini-PCIe Module with 2x LAN Ports, 2x 30cm cable, w/ 1x Universal Bracket with 2x RJ45 Cutout | V | V |
|  MEC-USB-M102-30/UB1214 | Mini-PCIe Module with 2x USB 3.2 Gen1 Ports, 1x 30cm cable, 1x Universal Bracket with 2x USB Cutout | V | V |

V : Compatible

Updated: Oct. 20, 2023